

NFCG

T R A D E

VALVEXTM
Power of Quality



tucai[®]

HALCOR

CherBros
more than fittings



ROTHENBERGER
pipetool technologies at work

gebo
FITS BETTER!

aquaPUR

VALROM
INDUSTRIE

ZENNER



POMPE
IBO-DAMBAT

thermostahl

SMACK

ARISTON
The home of sustainable comfort



Saunier Duval
Întotdeauna alături de tine

VIESMANN



belform
in apele tale

ferroli

Roca

GROHE



Ideal Standard



SANOTECHNIK[®]
INTERNATIONAL



FERONERIA

wirquin

hansgrohe

FAYANS

Rea

SUPRAHERM[®]
PIPE & HEATING SYSTEMS

CUPRINS

Capitol	Denumire
1	Robineți și fittinguri
2	Țevi și accesorii
3	Apă, gaz și măsurare temperatură și presiune
4	Stocare și filtrare apă
5	Încălzire
6	Baterii
7	Obiecte sanitare
8	Mobilier baie
9	Sudură, feronerie, scule și mașinării
10	Electrice și tablouri electrice
11	Șine și ușițe de vizitare
12	Profile decor

NFG
TRADE
SOLUTII COMPLETE
PENTRU CASA TA

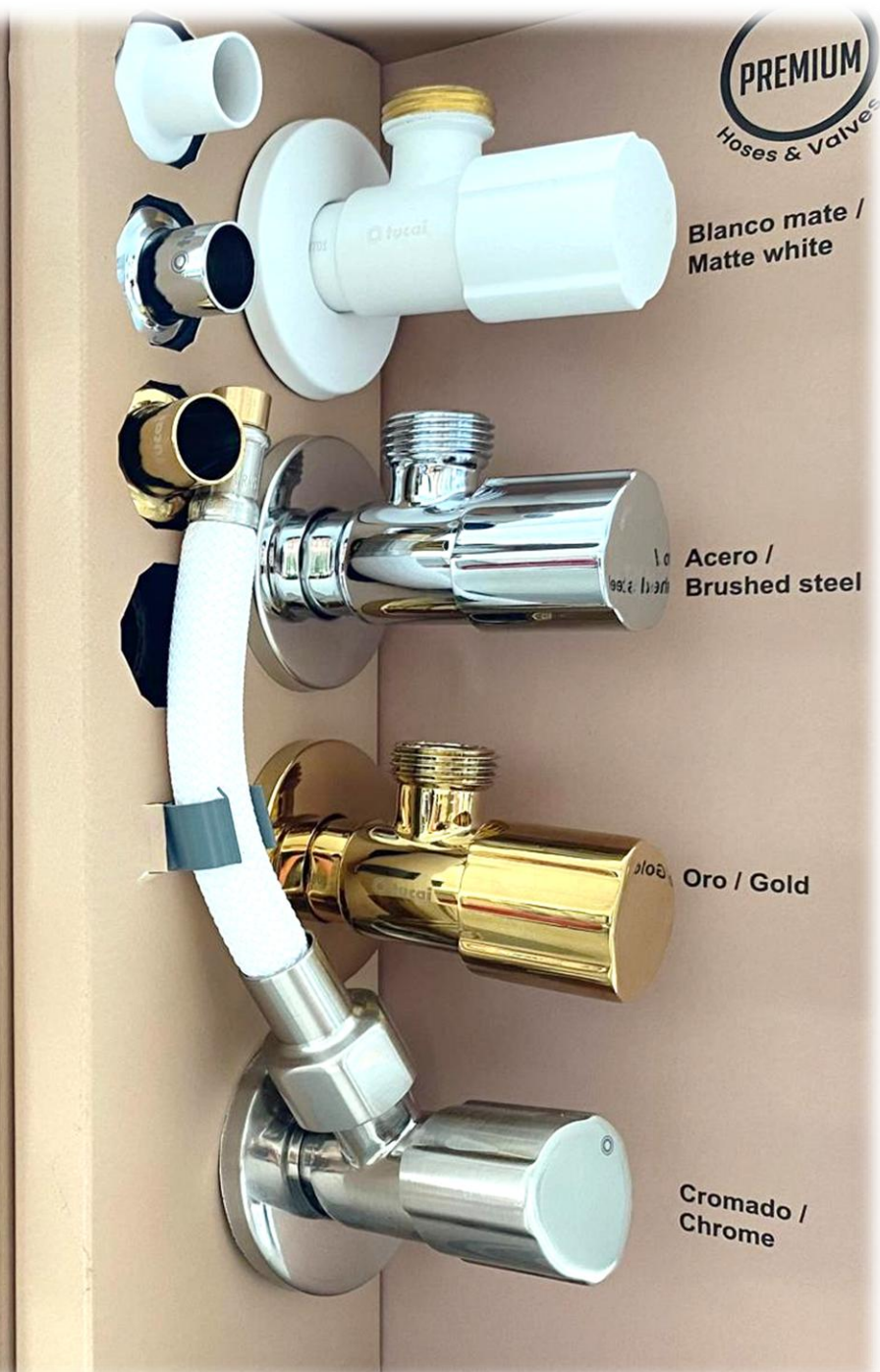

 **tucai**[®]



Robinet de trecere
PN25 FI

1/2" 0200010R
3/4" 0200011R
1" 0200012R



Robinet de trecere
filet
Exterior PN25 FE

1/2" 0200016R
3/4" 0200017R
1" 0200018



Robinet de trecere
PN45 FI

1/2" 0200013R
3/4" 0200014R
1" 0200015R



Robinet de trecere filet
Exterior PN45 FE

1/2" 0200019R
3/4" 0200020
1"



Robinet coltar NEW

1/2 x 3/8 0400021
1/2 x 1/2 0400022
1/2 x 3/4 0400023



ROBINET COLTAR
CERAMIC
1/2X3/4"

RCT1/23/4



ROBINET COLTAR
CERAMIC
1/2X3/8"

RCT1/23/8 25



ROBINET COLTAR
1/2X1/2"
SMART

RCTE1/2



ROBINET COLTAR
1/2X3/4"
SMART

RCTE3/4



ROBINET COLTAR
1/2X3/8"
SMART

RCTE3/8

ROBINET COLTAR
CERAMIC 1/2X1/2"

RCT1/21/2

Cap.1



RACORD APA
MONOCOMANDA
3/8" L17

400 mm - RT173/8400
500 mm - RT173/8500
600 mm - RT173/8600



RACORD APA
MONOCOMANDA
3/8" L37

400 mm - RT373/8400
500 mm - RT373/8500
600 mm - RT37/8600



RACORD APA 3/8-3/8"

300 mm - RT3/8300
400 mm - RT3/8400
500 mm - RT3/8500
600 mm - RT3/8600
800 mm - RT3/8800



RACORD APA 1/2 3/8

300 mm - RT1/2300
400 mm - RT1/2400
500 mm - RT1/2500
600 mm - RT1/2600
800 mm - RT1/2800



RACORD APA
MONOCOMANDA L17

100 mm - RT17/100
300 mm - RT17/300
400 mm - RT17/400
500 mm - RT17/500
600 mm - RT17/600
800 mm - RT17/800
1000 mm - RT17/1000



RACORD APA
MONOCOMANDA
1/2" L37

300 mm - RT37/300
400 mm - RT37/400
500 mm - RT37/500
600 mm - RT37/600
800 mm - RT37/800
1000 mm - RT37/1000



RACORD APA 1/2 1/2

1m - RAT1000
1,2m - RAT1200
1,5 m - RAT1500
2 m - RAT2000
300 mm - RAT300
400 mm - RAT400
500 mm - RAT500
600 mm - RAT600
800 mm - RAT800



RACORD APA 1/2 1/2 MT

300 mm - RMT300
400 mm - RMT400
500 mm - RMT500
600 mm - RMT600



RACORD HIDROFOR DREPT

3/4 - 500 : 204717
3/4 - 600 : 204718
1 - 500 : 204741
1 - 600 : 204742



RACORD HIDROFOR CU COT

3/4 - 500 : 2464
3/4 - 600 : 2465
1 - 500 : 2480
1 - 600 : 2481



AERATOR FE M24 50%
ANTIVANDALISM

202008



AERATOR FE M24
50% ECO TUCAI
Filet exterior
201997



AERATOR FI H22
(baterii bucătărie)
50% ECO TUCAI
Filet interior
201999



FURTUN DUS FLEXIBIL

204294

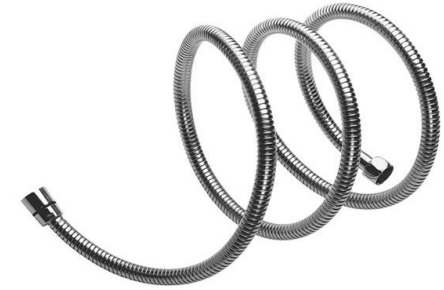

FURTUN DUS FLEXIBIL 1,5 m

FDFT



AERATOR BIDEU 50% ECO

202009



Aerator pentru dus,
9L / min

202004



Kit 2 aeratoare M24 ECO 50%
(red
consum apa) cu cheie

202001



FURTUN DUS PLATINIUM
TUCAI

1.75 M
201962

tucai



Cap.1



FURTUN ALIMENTARE
MASINA DE SPALAT 2M

205480



FURTUN ALIMENTARE
MASINA DE SPALAT
PIULITA PLASTIC 2M

205481



FURTUN ALIMENTARE
MASINA DE SPALAT
PIULITA METALICĂ 3M

205483



FURTUN DE EVACUARE
MASINA DE SPALAT 2 M

205485



FURTUN EVACUARE
MASINA DE SPALAT 3m

205486



FURTUN ALIMENTARE
MASINA DE SPALAT 4M

206523



FURTUN ALIMENTARE
MASINA DE SPALAT
PIULITA PLASTIC 3M

206380



FURTUN EVACUARE
MASINA DE SPALAT
EXTENSIBIL 700/2000

205487

GARANȚIE

Tucai SA garantează că produsele sale NU prezintă defecte de fabricație.

NU sunt defecte de fabricație și, prin urmare, nu pot fi acoperite de această garanție: (1) uzură normală, îmbătrânire și coroziune; (2) accident, dezastru sau caz de forță majoră; (3) utilizarea greșită, aplicarea și/sau instalarea greșită, vina sau neglijența sau a Cumpărătorului sau a unei terțe părți; (4) depozitarea

necorespunzătoare a produselor.

Garanție este valabilă 5 ani pentru conectorii împletite din oțel inoxidabil.

Perioada de garanție începe de la data livrării (sau data la care se consideră că livrarea a fost efectuată în mod corespunzător) a produselor către Cumpărător.

TUCAI GROUP își asumă răspunderea numai pentru daunele directe suferite de către Client ca urmare a defectelor de fabricație ale produselor.



VIKING Robinet de evacuare din fontă (pentru racordarea furtunului cu cuplaj rapid)

1/2" 1292200
3/4" 1293200



VIKING Robinet de trecere din fontă

1/2" 1292150
3/4" 1293150
1" 1294150



ORO Robinet sferic, cu presetupă și fluture de aluminiu (versiunea cu filet interior-exterior)

1/2" 1472660
3/4" 1473660
1" 1474660



ORO Robinet sferic, cu presetupă și fluture de aluminiu (versiunea cu filet interior-interior)

1/2" 1472620
3/4" 1473620
1" 1474620



ONYX Robinet sferic, pasaj total, cu presetupă și fluture de aluminiu (versiunea cu filet interior-interior)

1/2" 1452400
3/4" 1453400



NYX Robinet sferic, pasaj total, cu presetupă și fluture de aluminiu (versiunea cu filet interior-exterior)

1/2" 1452480
3/4" 1453480



ONYX Robinet sferic, pasaj total, cu presetupă și manetă de oțel (versiunea cu filet interior-exterior).

1/2" 1452460
3/4" 1453460



ONYX Robinet sferic, pasaj total, cu presetupă și manetă de oțel (versiunea cu filet interior-interior)

1/2" 1452320
3/4" 1453320



ORO Robinet sferic, manetă de oțel (versiunea cu filet interior-interior)

1 1/4" 1475600
1 1/2" 1476600
2" 1477600



ONYX Robinet sferic, pasaj total, cu presetupă și manetă de oțel (versiunea cu filet interior-interior)

2 1/2" 9007930
3" 9007920
4" 9007910



ORO Robinet sferic, cu
presetupă și fluture de aluminiu
(versiunea cu racord olandez)

1/2" 1472680
3/4" 1473680
1" 1474680



SPIN Robinet cu semiolandez,
din alamă, cu fluture de aluminiu

1/2" 1474680



OLIGO Robinet sferic dublu
serviciu nichelat, cu manetă de
aluminu

1/2" 1592200
3/4" 1593200



EKO
Robinet colțar cromat

1/2"-3/8" 1482110
1/2"-1/2" 1482120
1/2"-3/4" 1482130



BASE
Robinet colțar cromat cu ventil

1/2"-3/8"
1/2"-1/2"
1/2"-3/4"



STAR
Robinet colțar cromat, cu cartuș
ceramic
1/2"-3/8"
1/2"-1/2"
1/2"-3/4"



VEGA
Robinet colțar cromat, cu cartuș
ceramic

1/2"-3/8"



THERMO SET
Set termostatic colțar complet,
nichelat

4445250



ACTIV PLUS
Set radiatoare unghi

1/2" 4512680



VECTOR
Robinet radiator retur Z0-K-15
colțar, nichelat

1/2' 4520080



ACTIV PLUS
Robinet radiator tur drept,
nichelat
1/2" 4582070



MINI
Robinet sferic cromat
(versiunea cu filet interior-
exterior)
1/2" 1470010



ORION
Robinet sferic pentru gaz, cu
fluture de aluminiu (versiunea cu
filet interior-interior)
1/2" 3412070
3/4" 3413070



ORION
Robinet sferic pentru gaz, cu
fluture de aluminiu (versiunea cu
filet interior-exterior)
1/2" 3412150
3/4" 3413150



PIZA
Filtru impurități Y alamit
1/2" 4990000
3/4" 4990010
1" 4990020



ALFA
Aerisitor automat cu supapă de
închidere, alamit
1/2" 4700360



PROFF Suport din oțel pentru
distribuitoare
6090140



BASE
Set distribuitor inox 5 căi
DIMENSIUNI:
1" 6085330

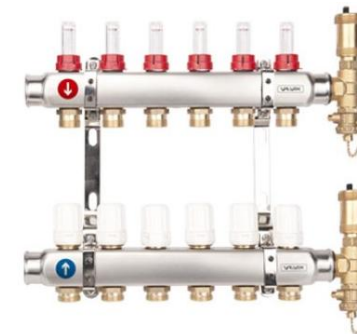

BASE
Set distribuitor inox cu diblmetru
4 căi 1" 6085620
5 căi 1" 6085630
6 căi 1" 6085640
8 căi 1" 6085660



VELA Cutie pentru distribuitori,
montabilă în perete
(metalică, emailată)
435x575 6091610
565x575 6091620
665x575 6091640
965x575 6091650



COT 1/2" FI-FE PLUS	1120040417
COT 1/2" FI PLUS	1110040407
COT 1" FI-FE PLUS	1120080807
COT 3/4" FI-FE PLUS	1120060607
COT 3/4" FI PLUS	1110060607



MUFA ALAMA 1/1" PLUS	1140080000
MUFA ALAMA 1/2" PLUS	1140040000
MUFA ALAMA 3/4" PLUS	1140060000



NIPLU 1/1" PLUS	1210080807
NIPLU 1/2" PLUS	1210040417
NIPLU 3/4" PLUS	1210060617



NIPLU REDUS 1/2"*3/8" PLUS	1220030407
NIPLU REDUS 1/1"*1/2" PLUS	1220040807
NIPLU REDUS 1/1"*3/4" PLUS	1220060807
NIPLU REDUS 3/4"*1/2" PLUS	1220040607



REDUCTIE 1/2"*3/4" PLUS	1230040607
REDUCTIE 1/1"*1/2" PLUS	1230040807
REDUCTIE 1/1"*3/4" PLUS	1230060807



TEU ALAMA 1/1" PLUS	1130080807
TEU ALAMA 1/2" PLUS	1130040407
TEU ALAMA 3/4" PLUS	1130060607



Capac alamă

CAPSP1 - 1"
CAPSP1/2 - 1/2"
CAPSP3/4 - 3/4"
CAPSP3/8 - 3/8"



Cot alamă FI-FE

CSP1/2FE - COT 1/2 "
CSP11/2M - COT 1 1/2 "
CSP11/4M - COT 1 1/4 "
CSP1FE - COT 1"
CSP3/4FE - COT 3/4 "
CSP3/8M - COT 3/8 "



Cot alamă FI

CSP1/2FI - 1/2 "
CSP11/2FI - COT 1 1/2 "
CSP11/4F - COT 1 1/4 "
CSP1FI - COT 1"
CSP2FI - COT 2"
CSP3/4FI - COT 3/4 "



Dop alamă FE

DSP1/2FE - 1/2 "
DSP1FE - 1"
DSP3/4FE - 3/4 "
DSP3/8 - 3/8 "



Mufă rapidă FI

MRSP201/2F - 20* 1/2 "
MRSP253/4F - 25* 3/4 "
MRSP4011/4F - 40*11/4 "
MRSP5011/2F - 50*11/2 "



Mufă rapidă FE

MRSP201/2M - 20* 1/2 "
MRSP253/4M - 25* 3/4 "
MRSP4011/4M - 40*11/4 "
MRSP5011/2FE - 50*11/2 "



Mufă alamă

MSP1 - 1"
MSP1/2 - 1/2 "
MSP11/2 - 11/2 "
MSP11/4 - 11/4 "
MSP2 - 2"
MSP3/4 - 3/4 "
MSP3/8 - 3/8 "



Mufă redusă

MSPR1/23/4 - 3/4 - 1/2 "
MSPR3/4/1 - 3/4 - 1"
MSPR3/81/2 - 3/8 - 1/2 "

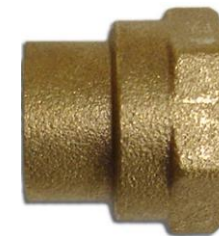

Niplu cupru M-M

NCSP151/2 - 15* 1/2 "
NCSP181/2 - 18* 1/2 "
NCSP223/4 - 22* 3/4 "
NCSP281 - 28*1 "



Niplu cupru FE

NCSP151/2FE - 15* 1/2 "
NCSP183/4M - 18* 3/4 "
NCSP181/2FE - 18* 1/2 "
NCSP223/4FE - 22* 3/4 "
NCSP281FE - 28*1 "



Niplu redus

NRSP1/13/4 - 1/1" * 3/4"
NRSP1/23/8 - 1/2" * 3/8"
NRSP1/43/8 - 1/4" * 3/8"
NRSP211/2 - 2" - 1 1/2"
NRSP211/4 - 2" - 1 1/4"



Niplu redus

NRSP3/41/2 - 3/4" * 1/2"
NSP1/21 - 1/2" * 1/1"
NSP1/41/2 - 1/4" * 1/2"
NSP11/411/2 - 1 1/4" * 1 1/2"
NSP111/2 - 1" * 1 1/2"
NSP111/4 - 1" * 1 1/4"



Niplu alamă

NSP1/1 - 1/1"
NSP1/2 - 1/2"
NSP1/4 - 1/4"
NSP11/2 - 1 1/2"
NSP11/4 - 1 1/4"
NSP2 - 2"
NSP3/4 - 3/4"
NSP3/8 - 3/8"



Prelungitor

PRESP1/2/1 - 1/2-1
PRESP1/23/4 - 1/2-3/4
PRESP1/23/8 - 1/2-3/8



Prelungitor

PRESP10 - 1/2 10MM
PRESP15 - 1/2 15MM
PRESP20 - 1/2 20MM
PRESP25 - 1/2 25MM
PRESP3/4/1 - 3/4-1
PRESP30 - 1/2 30MM
PRESP40 - 1/2 40MM
PRESP50 - 1/2 50MM



Reducție

RSP1/11/2 1/1" * 1/2"
RSP1/13/4 1/1" * 3/4"
RSP1/21/4 1/2" * 1/4"
RSP1/23/4 1/2" * 3/4"
RSP1/23/8 1/2" * 3/8"
RSP11/21 1 1/2" * 1"
RSP11/211/4 1 1/2" * 1 1/4"



Reducție

RSP11/41 - 1 1/4" * 1"
RSP11/43/4 - 1 1/4" * 3/4"
RSP2*11/2 - 2" * 1 1/2"
RSP21/2 - 2" * 1/2"
RSP211/2 - 2" * 1 1/2"
RSP211/4 - 2" * 1 1/4"
RSP3/81/4 - 3/8" * 1/4"



Suport perete

SUPSP151/2 - 1 5/8" * 1/2"
SUPSP18 - 1 7/8" * 1/2"



Teu alamă

TSP1 - 1/1"
TSP1/2 - 1/2"
TSP11/2 - 1 1/2"
TSP11/4 - 1 1/4"



Teu alamă

TSP2 2"
TSP3/4 3/4"
TSP3/8 3/8"



C15/45F Cot cupru 15*45 M-M
C15/90F Cot cupru 15*90 M-M
C18/45F Cot cupru 18*45 M-M
C18/90F Cot cupru 18*90 M-M
C22/45F Cot cupru 22*45 M-M
C22/90F Cot cupru 22*90 M-M
C28/45F Cot cupru 28*45 M-M
C28/90F Cot cupru 28*90 M-M
C35/45F Cot cupru 35*45 M-M
C35/90F Cot cupru 35*90 M-M
C42/90F Cot cupru 42*90 M-M
C54/90F Cot cupru 54*90 M-M

MR18/15F Mufa redusa cupru 18*15 M-M
MR22/15F Mufa redusa cupru 22*15 M-M
MR22/18F Mufa redusa cupru 22*18 M-M
MR28/15F Mufa redusa cupru 28*15 M-M
MR28/18F Mufa redusa cupru 28*18 M-M
MR28/22F Mufa redusa cupru 28*22 M-M
MR35*15 Mufa redusa cupru 35*15 M-M
MR35/18F Mufa redusa cupru 35*18 M-M
MR35/22F Mufa redusa cupru 35*22 M-M
MR35X28F Mufa redusa cupru 35*28 M-M
MR54/28 Mufa redusa cupru 54*28 M-M
MR35/28M Mufa redusa cupru 35*28 M-T



C15/45M Cot cupru 15*45 M-T
C15/90M Cot cupru 15*90 M-T
C18/45M Cot cupru 18*45 M-T
C18/90M Cot cupru 18*90 M-T
C22/45M Cot cupru 22*45 M-T
C22/90M Cot cupru 22*90 M-T
C28/45M Cot cupru 28*45 M-T
C28/90M Cot cupru 28*90 M-T
C35/45M Cot cupru 35*45 M-T
C35/90M Cot cupru 35*90 M-T

N28/1M Niplu cupru 28*1 M-T
N283/4M Niplu cupru 28*3/4 M-T
N35/1M Niplu cupru 35*1" M-T
N3511/4M Niplu cupru 35*1 1/4 M-T
NC54X2 Niplu cupru 54X2 M-T



N223/4F Niplu cupru 22*3/4 M-M
N28/1F Niplu cupru 28*1 M-M
N35/1F Niplu cupru 35*1 M-M
N54/2F Niplu cupru 54*2 M-M





CC15 Capac cupru 15
CC18 Capac cupru 18
CC22 Capac cupru 22
CC28 Capac cupru 28



MC15 Mufa cupru 15
MC18 Mufa cupru 18
MC22 Mufa cupru 22
MC28 Mufa cupru 28
MC35 Mufa cupru 35
MC42 Mufa cupru 42
MC54 Mufa cupru 54



TC18/15/18 Teu redus cupru 18-15-18
TC22/15/22 Teu redus cupru 22-15-22
TC22/18/22 Teu redus cupru 22-18-22
TC28/15/28 Teu redus cupru 28-15-28
TC28/18/28 Teu redus cupru 28-18-28
TC28/22/28 Teu redus cupru 28-22-28
TC35/18/35 Teu redus cupru 35-18-35
TC35/22/35 Teu redus cupru 35-22-35
TC35/28/28 Teu redus cupru 35-28-28
TC35/28/35 Teu redus cupru 35-28-35
TC54*28*54 Teu redus cupru 54-28-54
TC54x35x54 Teu redus cupru 54-35-54

CURBA TRECERE



CT15F 15 M-M
CT18F 18 M-M
CT22F 22 M-M

TCC15 Teu cupru 15
TCC18 Teu cupru 18
TCC22 Teu cupru 22
TCC28 Teu cupru 28
TCC35 Teu cupru 35
TCC42 Teu cupru 42
TCC54 Teu cupru 54



<p>CAPAC NEGRU</p>  <p>1/2 CNG1/2 3/4 CNG3/4 1 CNG1 1 1/2 CNG11/2 1 1/4 CNG11/4 2 CNG2 2 1/2 CNG21/2 3 CNG3</p>	<p>DOP NEGRU</p>  <p>1/2 DNG1/2 3/4 DNG3/4 1 DNG1 1 1/2 DNG11/2 1 1/4 DNG11/4 2 DNG2</p>	<p>COT NEGRU FE</p>  <p>1/2 FE CNG1/2M 3/4 FE CNG3/4M 1 FE CNG1M 1 1/4 FE CNG11/4M. 1 1/2 FE CNG11/2M 2 FE CNG2M</p>	<p>COT NEGRU FI</p>  <p>1/2 FI CNG1/2F 3/4 FI CNG3/4F 1 FI CNG1F 1 1/4 FI CNG11/4F 1 1/2 FI CNG11/2F 2 FI CNG2F</p>	<p>MUFA NEAGRA</p>  <p>3/8 MNG3/8 1/2 MNG1/2 3/4 MNG3/4 1 MNG1 1 1/4 MNG11/4 1 1/2 MNG11/2 2 MNG2</p>
<p>MUFA NEAGRA</p>  <p>1/2*3/8 MNG1/23/8M 3/4*1/2 MNG3/41/2 1*1/2 MNG11/2M 1*3/4 MNG13/4 1 1/4*3/4 MNG11/43/4 1 1/4*1 MNG11/41 2*1 MNG21</p>	<p>NIPLU NEGRU</p>  <p>1/2 NNG1/2 3/4 NNG3/4 1 NNG1 1 1/4 NNG11/4 1 1/2 NNG11/2 2 NNG2 3' NNG3</p>	<p>NIPLU NEGRU</p>  <p>3/4*1/2 NNG3/41/2 1X1/2 NNG11/2R 1*3/4 NNG13/4 1 1/4*3/4 NNG11/43/4 1 1/4*1 NNG11/41 1 1/2*3/4 NNG11/23/4 1 1/2*1 1/4 NNG11/2-11/4 2*1 NNG21 2*1 1/2 NNG211/2 2*1 1/4 NNG211/4</p>	<p>REDUCTIE NEAGRA</p>  <p>3/4*1/2 RNG3/41/2 1*1/2 RNG11/2 1*3/4 RNG13/4 1 1/4*1/2 RNG11/4*1/2 1 1/4*3/4 RNG11/43/4 1 1/4*1 RNG11/41 1 1/2X1/2 RNG11/2X1/2 1 1/2*3/4 RNG11/2*3/4 1 1/2*1 RNG11/21 1 1/2*1 1/4 FE RNG11/211/4M 2*1 FE RNG21 2*1 1/2 FE RNG211/2</p>	<p>TEU 90° NEGRU</p>  <p>1/2 TNG1/2 3/4 TNG3/4 1 TNG1 1 1/4 TNG11/4 1 1/2 TNG11/2 2 TNG2</p>

RACORD
OLANDEZ
NEGRU FI



1/2 FI RONG1/2F
3/4 FI RONG3/4F
1 FI RONG1F
1 1/2 FI RONG11/2F
1 1/4 FI RONG11/4F
2 FI RONG2F

RACORD
OLANDEZ
NEGRU FE



1/2 FE RONG1/2M
3/4 FE RONG3/4M
1 FE RONG1M
1 1/2 FE RONG11/2M
1 1/4 FE RONG11/4FE
2 FE RONG2M

DOP ZINCAT



1/2 DZN1/2
3/4 DZN3/4
1 DZN1
1 1/4 DZN114
1 1/2 DZN11/2
2 DZN2
3 DZN3

CAPAC ZINCAT



1/2 CZN1/2
3/4 CZN3/4
1 CZN1
1 1/4 CZN11/4
1 1/2 CZN11/2
2 CZN2
2 1/2 CZN21/2P
3 CZN3

COT ZINCAT FI



1/2 CZN1/2F
3/4 CZN3/4F
1 CZN1F
1 1/4 CZN11/4F
1 1/2 CZN11/2F
2 CZN2F
2 1/2 CZN21/2
3 CZN3F

COT ZINCAT FE



1/2 CZN1/2M
3/4 CZN3/4M
1 CZN1M
1 1/4 CZN11/4M
1 1/2 CZN11/2M
2 CZN2M
2 1/2 CZN21/2M
3 CZN3FE

MUFA ZINCATA



1/2 MZN1/2
3/4 MZN3/4
1 MZN1
1 1/4 MZN11/4F
1 1/2 MZN11/2.
2 MZN2
2 1/2 MZN21/2
3 MZN3
4 MZN4

MUFA REDUSA ZINCATA



3/4*1/2 MZN3/41/2
1*1/2 MZN11/2
1*3/4 MZN13/4
1 1/4*1 MZN11/41
1 1/2-1 1/4 MZN11/211/4
2*1 1/2 MZN2*1 1/2

RACORD OLANDEZ ZINCAT FI

3/8 ROZN3/8F
1/2 ROZN1/2F
3/4 ROZN3/4F
1 ROZN1F
1 1/4 ROZN11/4F.
1 1/2 ROZN11/2F
2 ROZN2F
2 1/2 ROZN21/2FI
3 ROZN3F



RACORD OLANDEZ ZINCAT FE

3/8 ROZN3/8M
1/2 ROZN1/2M
3/4 ROZN3/4M
1 ROZN1M
1 1/4 ROZN11/4M
1 1/2 ROZN11/2M
2 ROZN2M
2 1/2 ROZN21/2FE
3 ROZN3FE
4 ROZN4FE



TEU ZINCAT

1/2 TZN1/2
3/4 TZN3/4
1 TZN1
1 1/4 TZN11/4
1 1/2 TZN11/2
2 TZN2
2 1/2 TZN21/2
3 TZN3



RACORD RAPID QA

3/8" GHE3/8A
1/2" GHE1/2A
3/4" GHE3/4A
1" GHE1A
1 1/4" GHE5/4A
1 1/2" GHE6/4A
2" GHE2A



RACORD RAPID QI

3/8" GHE3/8I
1/2" GHE1/2I
3/4" GHE3/4I
1" GHE1I
1 1/4" GHE5/4I
1 1/2" GHE6/4I
2" GHE2I



RACORD RAPID ANB

2X1 RR2x1
4X2 RR4X2
1/2X1/2 RRANB1/2
3/4X1/2 GHE3/4-1/2
1X3/4 RRANB1/3/4
5/4X3/4 RRANB5/43/4
6/4X3/4 RRANB6/43/4



NIPLU ZINCAT



3/8	NZN3/8		
1/2	NZN1/2		
3/4	NZN3/4		
1	NZN1		
1 1/4	NZN11/4		
1 1/2	NZN11/2		
2	NZN2	1 1/4*1	NZN11/41
2 1/2	NZN21/2	1 1/2*1	NZN11/21
3	NZN3	1 1/2*1 1/4	NZN11/211/4
4	NZN4	21	NZN21
1/2*3/8	NZN3/81/2	2*1 1/2	NZN211/2
3/4*1/2	NZN3/41/2	2*1 1/4	NZN211/4
1*1/2	NZN11/2.	2 1/2*1 1/2	NZN211/2/11/2
1*3/4	NZN13/4	2 1/2*2	NZN21/22
1 1/2*1/2	NZN11/2*1/2	3-2	NZN3-2
1 1/2*3/4	NZN11/2*3/4	3*21/2	NZN3*21/2
1 1/4-1/2	NZN11/4-1/2		
1 1/4*3/4	NZN11/4*3/4		

RACORD COLIER



1/2	MGHE1/2
3/4	MGHE3/4
1	MGHE1
1 1/4	MGHE5/4
1 1/2	MGHE6/4
2	MGHE2
2 1/2	MGHE21/2
3	MGHE3
4	MGHE4

REDUCTIE ZINCATA



1/2*3/8	RZN1/23/8
3/4*1/2	RZN3/41/2
1*1/2	RZN11/2
1*3/4	RZN13/4
1 1/4*3/4	RZN11/43/4
1 1/4*1	RZN11/41
1 1/2*1/2	RZN11/21/2
1 1/2*3/4	RZN11/23/4
1 1/2*1	RZN11/21
1 1/2*1 1/4	RZN11/211/4
2*1/2	RZN21/2
2*1	RZN21
2*1 1/4	RZN211/4
2*1 1/2	RZN211/2
2 1/2*1 1/4	RZN21/2*1 1/4
2 1/2*1 1/2	RZN21/211/2
2 1/2*2	RZN21/22
3*1	RZN3*1
3*2	RZN32
3*2 1/2	RZN321/2
4*2	RZN42
4*3	RZN43

<p>Cot negru FI</p>  <p>1/2 CNG1/2FIK 3/4 CNG3/4FIK 1 CNG1FIK 1 1/4 1 1/2 CNG11/2FIK 2 2 1/2 3 4</p>	<p>Olandez negru FI</p>  <p>1/2 3/4 1 1 1/4 1 1/2 2 2 1/2 3 4</p>	<p>Niplu negru</p>  <p>1/2 NNG1/2K 3/4 NNG3/4K 1 NNG1K 1 1/4 1 1/2 2 2 1/2 3 4 3/4 x 1/2 NNG3/41/2K 1 x 1/2 NNG1*1/2K 1 x 3/4 1 1/4 x 1 NNG11/4*1K 1 1/2 x 1 1/4 2 x 1 1/4 2 x 1 1/2</p>	<p>Mufa neagra</p>  <p>1/2 MNG1/2K 3/4 MNG3/4K 1 MNG1K 1 1/4 ; 1 1/2 ; 2 ; 2 1/2 ; 3 ; 4</p>	<p>Reducție neagră</p>  <p>3/4 x 1/2 RNG3/4X1/2K 1 x 1/2 RNG1X1/2K 1 x 3/4 RNG13/4K 1 1/4 x 1 RNG11/41K 1 1/4 x 3/4 RNG11/43/4K 1 1/2 x 1 1/4 2 x 1 1/4 2 x 1 1/2</p>
<p>Cot negru FE</p>  <p>1/2 CNG1/2FEK 3/4 CNG3/4FEK 1 CNG1FEK 1 1/4 ; 1 1/2 ; 2 ; 2 1/2</p>			<p>Dop negru</p>  <p>1/2 DNG1/2K 3/4 DNG3/4K 1 DNG1K</p>	<p>Teu negru</p>  <p>1/2 TNG1/2K 3/4 TNG3/4K 1 TNG1K 1 1/4 ; 1 1/2 ; 2 ; 2 1/2 ; 3 ; 4</p>

<p>Cot zincat FI</p>  <p> $\frac{1}{2}$ CZN1/2FIK $\frac{3}{4}$ CZN3/4FIK 1 CZN1FIK $1 \frac{1}{4}$ CZN11/4FIK $1 \frac{1}{2}$ CZN11/2FIK 2 CZN2FIK $2 \frac{1}{2}$ 3 4 </p>	<p>Mufa zincată</p>  <p> $\frac{1}{2}$ MZN1/2K $\frac{3}{4}$ MZN3/4K 1 MZN1K $1 \frac{1}{4}$ MZN11/4K $1 \frac{1}{2}$ MZN11/2K 2 MZN2K </p>	<p>Teu zincat</p>  <p> $\frac{1}{2}$ TZN1/2K $\frac{3}{4}$ TZN3/4K 1 TZN1K $1 \frac{1}{4}$ TZN11/4K $1 \frac{1}{2}$ TZN11/2K 2 TZN2K $2 \frac{1}{2}$ 3 4 </p>	<p>Niplu zincat</p>  <p> $\frac{3}{4} \times \frac{1}{2}$ NZN3/4X1/2K $1 \times \frac{1}{2}$ $1 \times \frac{3}{4}$ NZN1X3/4K $1 \frac{1}{4} \times 1$ NZN11/4X1K $1 \frac{1}{2} \times 1$ NZN11/21K $1 \frac{1}{2} \times 1 \frac{1}{4}$ NZN11/2X11/4K $2 \times 1 \frac{1}{4}$ $2 \times 1 \frac{1}{2}$ </p>
<p>Cot zincat FE</p>  <p> $\frac{1}{2}$ CZN1/2FEK $\frac{3}{4}$ CZN3/4FEK 1 CZN1FEK $1 \frac{1}{4}$ CZN11/4FEK $1 \frac{1}{2}$ CZN11/2FEK 2 CZN2FEK $2 \frac{1}{2}$ DZN1/2K </p>	<p>Niplu zincat</p>  <p> $\frac{1}{2}$ NZN1/2K $\frac{3}{4}$ NZN3/4K 1 NZN1K $1 \frac{1}{4}$ NZN11/4K $1 \frac{1}{2}$ NZN11/2K 2 NZN2K $2 \frac{1}{2}$; 3; 4 </p>	<p>Reducție zincată</p>  <p> $\frac{3}{4} \times \frac{1}{2}$ RZN3/4X1/2K $1 \times \frac{1}{2}$ RZN1X1/2K $1 \times \frac{3}{4}$ RZN1X3/4K $1 \frac{1}{4} \times 1$ RZN11/4X1K $1 \frac{1}{2} \times 1$ RZN11/2X1K $1 \frac{1}{2} \times 1 \frac{1}{4}$ RZN11/2X11/4K $2 \times 1 \frac{1}{4}$ RZN2X11/4K $2 \times 1 \frac{1}{2}$ RZN2X11/2K </p>	<p>Olandez zincat</p>  <p> $\frac{1}{2}$ $\frac{3}{4}$ 1 $1 \frac{1}{4}$ $1 \frac{1}{2}$ 2 $2 \frac{1}{2}$ 3 4 </p>

Fitinguri

<p>Manșon alunecător</p>  <p>D= 16/20/25/32</p>	<p>Racord alamă FE</p> <p>16x1/2" 25x3/4" 16x3/4" 25x1" 20x1/2" 32x3/4" 20x3/4" 32x1" 25x1/2"</p> 	<p>Cot PPSU</p>  <p>D= 16/20/25/32</p>	<p>Teu PPSU</p> 
<p>Mufă egală PPSU</p>  <p>D= 16/20/25/32</p>	<p>Racord alamă FI</p> <p>16x1/2" 25x3/4" 20x1/2" 32x1" 20x3/4" 32x1" 25x1/2"</p> 	<p>Cot FE PPSU</p> <p>16x1/2" 20x1/2" 20x3/4" 25x3/4" 32x1"</p> 	<p>Teu FI alamă 25x3/4"</p> 
<p>Mufă redusă PPSU</p> <p>20x16 20x16 25x20 32x25</p> 	<p>Racord alamă cu hollender</p> <p>16x1/2" 20x1/2" 25x3/4" 25x1" 32x1"</p> 	<p>Cot alamă FI</p> <p>16x1/2" 20x1/2" 20x3/4"</p> 	<p>Teu alamă FI, cu flanșă susținere</p> <p>16x1/2" 20x1/2"</p> 
<p>Racord FE PPSU</p> <p>16x1/2" 25x3/4" 16x3/4" 25x1" 20x1/2" 32x3/4" 20x3/4" 32x1" 25x1/2"</p> 	<p>Garnitură plată EPDM pentru filet</p> <p>1/2" 3/4" 1"</p> 	<p>Cot alamă FI cu flanșă susținere</p> <p>16x1/2" 20x1/2" 20x3/4"</p> 	<p>Dop alamă</p> <p>D= 16/20</p> 



Teava PPR CT fibra
compozita PN25 20MM -
TPPRCCT20

PN25 25MM-TPPRCCT25
PN25 32MM-TPPRCCT32
PN25 40MM-TPPRCCT40
PN25 50MM-TPPRCCT50
PN25 63MM-TPPRCCT63
PN25 125MM-TPPRC125
PN20 75MM-TPPRC75
PN20 90MM-TPPRC90



Teava PPR cu
insertie de
ALUMINIU PN25

20MM - TPPR20I
25MM - TPPR25I
32MM - TPPR32I
40MM - TPPR40I
50MM - TPPR50I
63MM - TPPR63I



Teava PPR fara
insertie

20MM - TPPRF20
25MM - TPPRF25
32MM - TPPRF32
40MM - TPPRF40



Teava curbata PPR

20MM - TCB20
25MM - TCB25
32MM - TCB32



Teava curbata PPR
scurta

20MM - TCBS20
25MM - TCBS25
32MM - TCBS32



Clema PPR

20MM - CLPPR20
25MM - CLPPR25
32MM - CLPPR32
40MM - CLPPR40
50MM - CLPPR50



Cot PPR

20*45 - CPPR20/45
20*90 - CPPR20/90
25*45 - CPPR25/45
25*90 - CPPR25/90
32*45 - CPPR32/45
32*90 - CPPR32/90
40*45 - CPPR40/45
40*90 - CPPR40/90



Cot PPR

50*45 - CPPR50/45
50*90 - CPPR50/90
63*45 - CPPR63/45
63*90 - CPPR63/90
75*45 - CPPR75/45
90*45 - CPPR90*45
110*90 - CPPR110/90
125*90 - CPPR125/90



Cot PPR M/F

COT PPR 90*20MM (M/F) -
CPPRMF20/90

COT PPR 90 *25MM (M/F) -
CPPRMF90/25



Dop PPR

20MM DPPR20
25MM DPPR25
32MM DPPR32
40MM DPPR40
50MM DPPR50
63MM DPPR63

Dop PPR de proba



20MM- DPPRP20
25MM - DPPRP25

Teu egal PPR



20MM	TPPR20
25MM	TPPR25
32MM	TPPR32
40MM	TPPR40
50MM	TPPR50
63MM	TPPR63
110MM	TPPR110



Mufa PPR

20MM - MPPR20
25MM - MPPR25
32MM - MPPR32
40MM - MPPR40
50MM - MPPR50
63MM - MPPR63
110MM - MPPR110
125MM - MPPR125



Reductie PPR

25*20 - RPPR25/20
32*20 - RPPR32/20
32*25 - RPPR32/25
40*20 - RPPR40/20
40*25 - RPPR40/25
40*32 - RPPR40/32
50*20 - RPPR50/20
50*25 - RPPR50/25
50*32 - RPPR50/32

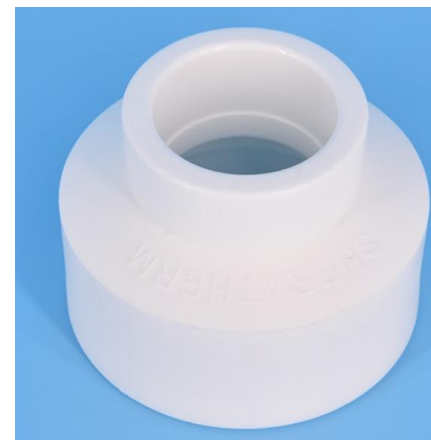

Reductie PPR

50*40 - RPPR50/40
63*25 - RPPR63/25
63*32 - RPPR63/32
63*40 - RPPR63/40
63*50 - RPPR63/50
90*75 - RPPR90/75
110*90 - RPPR110/90
125*110 - RPPR125/110



Teu PPR

25*20*20	TPPR25/20/20
25*20*25	TPPR25/20/25
25*25*20	TPPR25/25/20
32*20*32	TPPR32/20/32
32*25*32	TPPR32/25/32
40*20*40	TPPR40/20/40
40*25*40	TPPR40/25/40
40*32*40	TPPR40/32/40
50*20*50	TPPR50/20/50
50*25*50	TPPR50/25/50
50*32*50	TPPR50/32/50
50*40*50	TPPR50/40/50
63*20*63	TPPR63/20/63
63*25*63	TPPR63/25/63
63*32*63	TPPR63/32/63
63*40*63	TPPR63/40/63
63*50*63	TPPR63/50/63
75*40*75	TPPR75/40
75*50*75	TPPR75/50/75



ROBINET PPR

20MM - RPPR20E
25MM - RPPR25E
32MM - RPPR32EV
40MM - RPPR40EV
50MM - RPPR50EV
63MM - RPPR63EV



ROBINET PPR CU
HOLENDER 20

RPPR20E



COT CU SEMIOLANDEZ PPR

CSPPR20EV - 20X1/2 FI
CSPPR25X3/4 - 25X3/4 FI



TRUSA SUDAT TEVI PPR

PPR-SS32X - 20-32 MM
PPR-SS63X - 20-63 MM
TSPPR32 - 32MM
TSPPR63 - 63MM



FOARFECA ROSIE TEVI 16-
40 PPR

F16/40

ADAPTOR PPR

A20*1/2FV - 20*1/2 F
A20*3/4FV - 20X3/4 F
A25*1/2FV - 25*1/2 F
A25*3/4FV - 25*3/4 F
A32/1FV - 32X1 F
A40*11/4FV - 40X11/4 F
A50*11/2FV - 50*1.1/2 F
A63/2FV - 63X2 F
A75*21/2FV - 75X21/2 F
A90X3F - 90X3 FI



ADAPTOR PPR

A20*1/2MV - 20*1/2 M
A20*3/4MV - 20X3/4 M
A25*1/2MV - 25*1/2 M
A25*3/4MV - 25*3/4 M
A32/1MV - 32X1 M
A40*11/4MV - 40X11/4 M
A50*11/2MV - 50*1.1/2 M
A63/2MV - 63X2 M
A75*21/2FEV - 75X21/2 M
A90X3FEV - 90*3 M



COT PPR



CPPR20*1/2FV - 20X1/2 F
CPPR25*1/2FVAL - 25X1/2 F
CPPR25*3/4FV - 25X3/4 F
CPPR32*1FV - 32X1 F

COT PPR



C
C
CPPR25*3/4MV - 25X3/4 M
CPPR32X1MV - 32X1 M

COT PPR CU TALPA
20X1/2



CPPRT20*1/2V

FILTRU Y PPR



FPPR20V - 20MM
FPPR25V - 25MM

ROBINET TRECERE
VENTIL PPR 20MM SI
ROZETA



RACORD CU
SEMIOLANDEZ PPR



€
SPPR25*3/4V - 25X3/4 FI

RACORD PPR CU OLANDEZ

ROPPR201/2FV - 20X1/2 F
ROPPR25*3/4FV - 25X3/4 F
ROPPR32*1FV - 32X1 F
ROPPR40*11/4FV - 40X11/4 F
ROPPR50*11/2FV - 50X11/2 F
ROPPR63/2V - 63X2 F

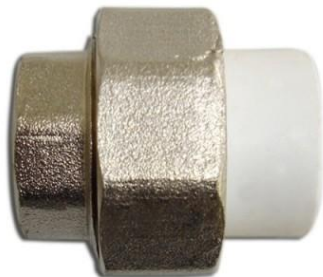

RACORD PPR CU OLANDEZ

ROPPR201/2MV - 20X1/2 M
ROPPR25*3/4MV - 25X3/4 M
ROPPR32*1MV - 32X1 M
ROPPR40*11/4MV - 40X11/4 M
ROPPR50*11/2MV - 50X11/2 M
ROPPR63/2MV - 63X2 M



TEU PPR



TPI
TPPR25*1/2FV - 25X1/2 F
TPPR25*3/4FV - 25X3/4 F
TPPR32*1FV - 32X1 F
TPPR32*3/4FVAL - 32X3/4 F



Cot compresiune 90°

CC20 – 20MM
CC25 – 25MM
CC32 – 32MM
CC40 – 40MM
CC50 – 50MM
CC63 – 63MM
CC75 – 75MM
CC90 – 90MM
CC110 – 110MM



**Cot compresiune 90°
FE**

CC201/2M - 20x1/2 FE
CC251M - 25x1"
CC251/2M - 25X1/2"
CC253/4M - 25X3/4"
CC32/1M - 32x1"
CC323/4M - 32X3/4"
CC4011/4M - 40X1 1/4"
CC5011/2M - 50X1 1/2"
CC63/2M 63x2"
CC7521/2FE - 75x 2 1x"
CC903M - 90x3"
CC110/4M -110x4"



**Cot compresiune 90°
FI**

CC251F - 25x1"
CC251/2F - 25x1/2"
CC253/4F - 25x3/4 "
CC32/1F - 32x1"
CC323/4F - 32x3/4"
CC4011/4F - 40x1 1/4"
CC401F - 40x1"
CC5011/2F - 50x1 1/2"
CC63/2F - 63x2"
CC7521/2F - 75x2 1/2"
CC90/3FI - 90x3"
CC110/4F - 110x4"



**Racord compresiune
FE**

RC1104M - 110x4"
RC201/2M - 20x1/2"
RC203/4M - 20x3/4"
RC251M - 25x1"
RC251/2FE - 25x1/2"
RC253/4M - 25x3/4"
RC32/1M - 32x1"
RC323/4FE - 32x3/4"
RC401M - 40x1"
RC4011/2M - 40x1 1/2"
RC4011/4M - 40x1 1/4"



**Racord compresiune
FE**

RC5011/2M - 50x1"1/2
RC50*11/4FE - 50x1"1/4
RC502M - 50x2
RC6311/2M - 63*11/2
RC63/2M - 63x2
RC7521/2M - 75 2 1/2
RC752M - 75*2
RC902M - 90x2
RC90/3 - 90x3



Racord compresiune FI

RC201/2F - 20x1/2
RC203/4FI - 20x3/4
RC251F - 25x1
RC251/2FI - 25x1/2
RC253/4F - 25x3/4
RC3211/4F -
32x1 1/4
RC32/1F - 32x1
RC323/4FI - 32x3/4
RC401F - 40x1
RC110/4FI - 110x4



Racord compresiune FI

RC4011/2F - 40x1"1/2
RC4011/4F - 40x1"1/4
RC5011/2F - 50x1"1/2
RC502F - 50x2
RC6311/2F - 63*11/2
RC63/2F - 63x2
RC7521/2F75 - 2 1/2
RC75x2F - 75x2
RC90/3F - 90x3



Mufa compresiune

MC20 - 20
MC25 - 25
MC32 - 32
MC40 - 40
MC50 - 50
MC63 - 63
MC75 - 75
MC90 - 90
MC110 - 110



Mufa redusa compresiune

MCR25/20 - 25/20
MCR32/25 - 32/25
MCR40/25 - 40/25
MCR40/32 - 40/32
MCR50/25 - 50/25
MCR50/32 - 50/32
MCR50/40 - 50/40
MRC63/32 - 63/32
MRC63/40 - 63/40
MRC63/50 - 63/50
MRC75/50 - 75/50
MCR75/63 - 75/63
MCR90*63 - 90/63
MCR90/75 - 90/75
MCR110/90 - 110/90



Dop compresiune

DC20 - 20
DC25 - 25
DC32 - 32
DC40 - 40
DC50 - 50
DC75 - 75
DC63 - 63
DC90 - 90
DCC110 - 110



Robinet apa PVC

76011012025



**Teu compresiune
derivat FE**

TC201/2M - 20x1/2
TC251/2FE - 25x1/2
TC253/4M - 25x3/4
TC32/1M - 32x1
TC323/4FE - 32x3/4
TC4011/4M - 40x1"1/4
TC5011/2M - 50x1"1/2
TC632M - 63x2



**Teu compresiune
derivat FI**

TC201/2F - 20x1/2
TC251F - 25x1
TC251/2FI - 25x1/2
TC253/4F - 25x3/4
TC32/1F - 32x1
TC323/4F - 32x3/4
TC401F - 40x1
TC4011/4F - 40x1"1/4
TC5011/4F - 50 1 1/4
TC5011/2F - 50x11/2
TC6311/2F - 63x11/2
TC632F - 63x2
TC110/4F - 110x4



**Robinet apa PVC
mufa-mufa**

RPVC20MM - 20
RPVC25M-M - 25
RPVC32M-M - 32



**Robinet apa PVC
mufa-hol**

RA201/2 - 20x1/2
RA253/4 - 25x3/4
RA32/1 - 32x1
RA4011/4 - 40x1 1/4
RA5011/2 - 50x1 1/2
RA63*2 - 63x2



Teu compresiune

TC20 - 20
TC25 - 25
TC32 - 32
TC40 - 40
TC50 - 50
TC63 - 63
TC75 - 75
TC90 - 90
TC110 - 110



Teu compresiune redus

TCR25/20/25 - 25-20-25
TCR32/20/32 - 32-20-32
TCR32/25/32 - 32-25-32
TCR40/25/40 - 40-25-40
TCR40/32/40 - 40-32-40
TCR50/32/50 - 50-32-50
TCR110/50 - 110-50-110



Reductie PEHD

46501110063 - 110/63
46501110075 - 110/75
46501160110 - 160/110
46501200160 - 200/160



Teu compresiune FI

TC90*21/2FI - 90x2 1/2
TC903F - 90*3

ȚEAVĂ PEHD



PN6

D25; L=200m

D32; L=200m

PN10

D20; L=100 /200 (m)

D25; L=25/50/100/200 (m)

D32; L=25/50/100/200 (m)

D40; L=100 m

D50; L=100 m

D63; L=100 m

D75; L=100 m. (Sau bara de 6 sau 13 m)

D90; L=100 m. (Sau bara de 6 sau 13 m)

D110; L=100 m. (Sau bara de 6 sau 13 m)

Pana la D1000

PN16

Pana D1200



POMPA CIRCULAȚIE
MAGI 25-60/180

1072



POMPA DRENAJ CTR
1100 FONTA CU
TOCATOR

1393



POMPA APE MURDARE
CU TOCATOR KRAKEN
1800W

000023



POMPA SUBMERSIBILA
4SKM 100 CU PANOU
CONTROL

1461



POMPA SUBMERSIBILA
4SKM 150 CU PANOU
CONTROL

1462



POMPA JET 100

1525



POMPA DP370

1632



POMPA
DIPPER 2400

1680



POMPA VIBRATILII VIM60
RUSSLAND 450

1724



POMPA
4SKM150, 15M CABLU
FARA PANOU

2010



POMPA CIRCULATIE
MAGI 32-100/180

2014



POMPA OLA 60
AUTO(0.45KW,230V)

2039



POMPA SUBMERSIBILA
DIPPER 2700 CU PANOU

2383



MOTOPOMPA NOVA
BZP20

2433



POMPA SUBMERSIBILA
4SD(M) 7/12, 20M
CABLU+PANOU
COMANDA

2509



POMPA JSW 100A 9M-
1.1KW

400000



POMPA DRENAJ IP 400
PLASTIC

460



POMPA SUBMERSIBILA
4SD(M) 2/12, 20M
CABLU+PANOU COMANDA

672



POMPA SUBMERSIBILA
4SD(M) 3/18, 20M
CABLU 1.5 kw

681



POMPA CIRCULATIE
BETA 32-80/180 CU
FITINGURI

851



POMPĂ CIRCULATIE BETA
25-80/180 CU FITINGURI

852



POMPĂ DRENAJ IP 550
PLASTIC

860



POMPĂ DRENAJ IP750
PLASTIC

861



POMPĂ DRENAJ IP1100
PLASTIC

864



POMPĂ DRENAJ IP 550 INOX

970



POMPA DRENAJ IP1100
INOX

973



P

976

PRESOSTAT MECANIC PC-
SK-2

AKCE-2086



VAS EXPANSIUNE INOX 24L

AKCE-3495



P

PC-59

AKCE-6606

IIC



FLANSA REZERVOR

CZES-2592



FITINGURI 25MM
OSPR-4726

FITINGURI 32MM
CZES-3947



HIDROFOR ADANCIME
50L DP370

DP370-H50



RACORD FLEXIBIL 1/2*1
30CM (HIDORFOR TF)

HHJH



HIDROFOR WZCH 250
RIDICARE PRESIUNE

HYDR-0102



HIDROFOR JET 100A 24L
TF

HYDR-3687



HIDROFOR JSW 150/24L

HYDR-5643



HIDROFOR JET 100A 50L

HYDR-5817



HIDROFOR JSW 150/50L

HYDR-9409



HIDROFOR ADANCIME
DP355 55L

HYDR-9979



POMPĂ DRENAJ IPE 400
PLASTIC

IPE400



CONTROLER M-31 0.75-4KW
400V

M-31



POMPĂ MWQ 50/3000 400V

MWQ



POMPĂ CIRCULATIE NOVA
25-40/180 CU FITINGURI

NOVA25/40/180



POMPĂ CIRCULATIE NOVA
25-60/180 CU FITINGURI

NOVA25/60/180



POMPA SUBMERSIBILA
DIPPER 2700

OPA000707



MANOMETRU 10 BARI

OSPR-0943



PRESOSTAT MECANIC
PC-2FE

PC2FE



POMPĂ DRENAJ FONTA CTR
550

POMP-0388



POMPA CIRCULATIE BETA
CU FITINGURI

25-40/180 - POMP-0838
25-60/180 - POMP-3431



POMPĂ SUBMERSIBILĂ
4SKM100,15M CABLU
FARA PANOU

POMP-0981



POMPĂ CIRCULATIE OHI
MECANICA

25-40/180 - POMP-25/40/180
25-80/180 - POMP-7025
32-60/180 - POMP-3661
32-80/180 - POMP-4446



POMPA JSW 150 -
POMP-9773

POMP-9773



POMPĂ SUBMERSIBILĂ
STING (0.37KW,230V)
CABLU FARA PANOU

STING0.37KW



POMPA SUBMERSIBILĂ
H-SWQ 1800-230V

POMP-3804



POMPĂ JET DP355AS

POMP-4771



POMPĂ JET 100A 9M-
1.1KW

POMP-8897



VAS HIDROFOR 24L

ZBIO-0242



VAS HIDROFOR 50L

ZBIO-1178



VAS EXPANSIUNE INOX
50L

ZBIO-6688

Tubulatură & fittinguri fonoabsorbante pentru canalizare interioară

 <p>Tub PP Fonoabsorbant</p> <p>D32 - L= 250/ 500/ 1000 D125 - L= 500/ 1000/ 2000 D160 - L= 500/ 1000/ 2000</p>	<p>Reducție excentrică</p> <p>D40/32 D50/32 D125/110 D160/125</p> 	<p>Manșon D32</p> 	<p>Ramnificație 45 grade</p> <p>D32/32 D125/125 D160/160</p> 
	<p>Ramnificație 87 grade</p> <p>D32/32</p> 	<p>Cot 87 grade</p> <p>D32 D125 D160</p> 	<p>Cot 45 grade</p> <p>D32 D160</p> 



Țeavă PVC

SN2

D110X2,2; L= 1/2/3/4/6 m
D125X2,5; L= 1/2/3/4/6 m
D160X3,2; L= 1/2/3/4/6 m
D200X3,9; L= 1/2/3/4/6 m
D250X4,9; L=1/2/3/4/6 m
D315X6,2; L=1/2/3/4/6 m
D400X7,8; L=1/2/3/4/6 m
D500X9,8; L=1/2/3/4/6 m

SN4

D110X3,2; L= 1/2/3/4/6 m
D125X3,2; L= 1/2/3/4/6 m
D160X4; L= 1/2/3/4/6 m
D200X4,9; L= 1/2/3/4/6 m
D250X6,2; L= 1/2/3/4/6 m
D315X7,7; L= 1/2/3/4/6 m
D400X9,8; L= 1/2/3/4/6 m
D500X12,3; L= 1/2/3/4/6 m
D630X15,4; L= 1/2/3/4/6 m

SN8

D110X3,4; L= 1/2/3/4/6 m
D125X3,7; L= 1/2/3/4/6 m
D160X4,7; L= 1/2/3/4/6 m
D200X5,9; L= 1/2/3/4/6 m
D250X7,3; L= 1/2/3/4/6 m
D315X9,2; L= 1/2/3/4/6 m
D400X11,7; L= 1/2/3/4/6 m
D500X14,6; L= 1/2/3/4/6 m
D630X18,4; L= 3/4/6 m

PVC

Clapetă antiretur cu închizător



D110
D125
D160
D200
D250
D315
D400

Curbă canal 15°

D110
D125
D160
D200
D250
D315
D400
D500



Curbă canal 30°

D110
D125
D160
D200
D250
D400
D500



Curbă canal 45°

D110
D125
D160
D200
D250
D315
D400
D500
D630



Curbă canal 67°

D110
D125
D160
D200



Curbă canal 87°

D110
D125
D160
D200
D250
D315
D400
D500
D630



Dop canal PVC

D110mm
D125mm
D160mm
D200mm
D250mm
D315mm
D400mm
D500mm
D630mm



PVC

Mufă canal cu opritor



D110
D125
D160
D200
D315
D400

Piesă inspecție canal



D110
D125
D160
D200
D250
D315
D400

Ramificație canal 45°



D110x110mm
D125x125mm
D160x160mm
D200x200mm
D250x250mm
D315x315mm
D400x400mm

Ramificație canal 87°



D110x110mm
D125x125mm
D160x160mm
D200x200mm

Mufă canal



D110
D125
D160
D200
D250
D315
D400
D500
D630

Țeavă pentru cămine



D315
D400

Ramificație canal 87°



D250x250mm
D315x315mm
D400x400mm
D630x630mm

PVC

Ramificație redusă 45°

D160x110mm
D160x125mm
D200x125mm
D250x110mm
D250x125mm
D250x160mm
D250x200mm
D315x110mm
D315x125mm
D315x160mm
D315x200mm
D400x200mm
D400x250mm
D400x315mm
D500x160mm
D500x200mm
D500x250mm
D500x315mm
D500x400mm



Ramificație redusă 87°

D160x125mm
D200x125mm
D250x110mm
D250x125mm
D250x160mm
D250x200mm
D315x110mm
D315x160mm
D315x200mm
D315x250mm
D400x160mm
D400x200mm
D400x250mm
D400x315mm
D500x160mm
D500x200mm
D500x250mm
D500x315mm
D500x400mm



Reducție canal

D125x110mm
D160x110mm
D160x125mm
D200x110mm
D200x125mm
D200x160mm
D250x110mm
D250x160mm
D250x200mm
D315x160mm
D315x200mm
D315x250mm
D400x160mm
D400x200mm
D400x250mm
D400x315mm
D500x200mm
D500x250mm
D500x315mm
D500x400mm
D630x400mm
D630x500mm



Branșament 45°

D160x110
D200x110
D200x160
D200x160
D250x110
D250x160
D250x160
D250x200
D315x125
D315x160
D315x200
D315x250
D400x160
D400x200
D400x250
D500x160
D500x200
D500x250
D500x315
D630x200
D630x315



PVC

Branșament 87°



D200x110mm
D200x125mm
D200x160mm
D250x110mm
D250x200mm
D250x160mm
D315x110mm
D315x160mm
D315x200mm

D400x160mm
D400x200mm
D400x250mm
D500x160mm
D500x200mm
D500x250mm
D500x315mm
D630x200mm

Sifon vizitabil



D110
D125
D160

ȚEAVĂ DRENAJ PVC



L=6m

SN2	SN4	SN8
D160 F-180gr	D110 F-180gr	D110 F-180gr
D160 F-270gr	D110 F-270gr	D110 F-270gr
D160 F-360gr	D110 F-360gr	D110 F-360gr
D160 F-90gr	D110 F-90gr	D125 F-360gr
D200 F-180gr	D125 F-180gr	D160 F-180gr
D200 F-360gr	D125 F-270gr	D160 F-270gr
D200 F-90gr	D125 F-360gr	D160 F-270gr
D250 F-180gr	D160 F-180gr	D160 F-360gr
D250 F-360gr	D160 F-270gr	D200 F-180gr
D315 F-180gr	D160 F-360gr	D200 F-270gr
D315 F-270gr	D200 F-180gr	D200 F-360gr
D315 F-360gr	D200 F-270gr	D200 F-90gr
D400 F-180gr	D200 F-360gr	D250 F-180gr
D400 F-270gr	D250 F-180gr	D250 F-270gr
	D250 F-270gr	D250 F-360gr
	D250 F-360gr	D250 F-90gr
	D315 F-180gr	D315 F-180gr
	D315 F-270gr	D315 F-270gr
	D315 F-360gr	D315 F-360gr
	D400 F-180gr	
	D400 F-270gr	
	D400 F-360gr	
	D400 F-90gr	

BAZĂ GEIGER CU SIFON 45° *

NFG
TRADE
SOLUTII COMPLETE
PENTRU CASA TA



D400- 160/45g H=1m
D400-160/45g H=1,5m
D400-160/45g H=1m
D400-160/45g H=2m
D400-200/45g H=1,5m
D400-200/45g H=1m
D400-200/45g H=2m
D500-160/45g H=1,5m
D500-160/45g H=1m
D500-160/45g H=2m
D500-200/45g H=1,5m
D500-200/45g H=1m
D500-200/45g H=2m

* Produs disponibil la
comanda

BAZĂ GEIGER 90° *



D400- 160/90g H=1,5m
D400-160/90g H=1m
D400-160/90g H=2m
D400-200/90g H=1m
D400-200/90gr H=1,5m
D400-200/90g H=2m
D500-160/90g H=1,5m
D500-160/90g H=1m
D500-200/90g H=1,5m
D500-200/90g H=1m

ȘA MENCANICĂ 90° unghi de reglaj pana la 10°



D200x160
D250x160
D315x160
D400x160

BAZĂ DE TRECERE PENTRU CĂMINE 3 INTRĂRI-1 IEȘIRE



D400 x 160
D400 x 200
D400 x 250
D400 x 315

BAZĂ DE TRECERE PENTRU CĂMINE 1 INTRARE-1 IEȘIRE



D160 x 160
D200 x 200
D315 x 160
D400 x 160
D400 x 200
D400 x 250
D400 x 315
D400 x 400

GARNITURĂ MANȘETĂ
TELESCOPICĂ



GRĂTAR COMPOZIT B125



GRĂTAR GEIGER CU RAMĂ
DIN FONTĂ

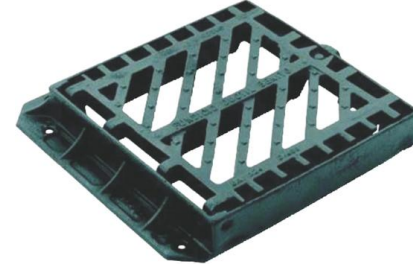

D400 360x288
C250 420x420
C250 440x440
D400 445x445

PIESĂ TRECERE CĂMIN
PVC-BETON



D110 L=110mm
D110 L=240mm
D125 L=240mm
D160 L=240mm
D200 L=240mm
D250 L=240mm
D315 L=240mm
D400 L=240mm
D500 L=240mm
D500 L=240mm
D630 L=240mm

CAPAC FONTA
B125/A15/D400



PT TUB PVC D315

GRĂTAR FONTĂ
D400



PT TUB PVC D315

CAPAC CĂMIN PP A15



D200
D315
D355
D400



ȚEAVĂ PVC GRI IGNIFUGĂ

D32

L=0,25m

L=0,5m

L=1m

L=2m

L=4m

D40

L=0,25m

L=0,5m

L=1m

L=2m

L=4m

D50

L=0,25m

L=0,5m

L=1m

L=2m

L=3m

L=4m

D110

L=0,25m

L=0,5m











L=1m

L=2m

L=3m

L=4m

L=6m

<p>Teava PP 32*1.8</p> <p>250mm TPP32/250 500mm TPP32/500 1000mm TPP32/1000 1500mm TPP32/1500 2000mm TPP32/2000 3000mm TPP32/3000</p> 	<p>Teava PP 40*1.8</p> <p>250mm TPP40/250 500mm TPP40/500 1000mm TPP40/1000 1500mm TPP40/1500 2000mm TPP40/2000 3000mm TPP40/3000</p> 	<p>Teava PP 50*1.8</p> <p>250mm TPP50/250 500mm TPP50/500 1000mm TPP50/1000 1500mm TPP50/1500 2000mm TPP50/2000 3000mm TPP50/3000</p> 	<p>Teava PP 75*1.9</p> <p>250mm TPP75/250 500mm TPP75/500 1000mm TPP75/1000 2000mm TPP75/2000 3000mm TPP75/3000</p> 	<p>Teava PP 110*2.7</p> <p>250mm TPP110/250 500mm TPP110/500 750mm TPP110/750 1000mm TPP110/1000 1500mm TPP110/1500 2000mm TPP110/2000 3000mm TPP110/3000</p> 
<p>Teava PP 125*3.1</p> <p>250mm TPP125/250 500mm TPP125/500 1000mm TPP125/1000 2000mm TPP125/2000 3000mm TPP125/3000</p> 	<p>Teava PP 160</p> <p>1000mm TPP160/1 2000mm TPP160/2 3000mm TPP160/3</p> 	<p>Mufa PP</p>  <p>32 MPP32 40 MPP40 50 MPP50 75 MPP75 110 MPP110 125 MPP125 160 MPP160</p>	<p>Piesa curatire PP</p>  <p>50 PCPP50 75 PCPP75 110 PCPP110 125 PCPP125 160 PCPP160</p>	<p>Piesa capat coloana de ventilatie</p>  <p>50 PCCV50 75 PCCV75 110 PCCV110 160 PCCV160</p>

Reductie PP

40*32	RPP40/32
50*32	RPP50/32
50*40	RPP50/40
75*40	RPP75/40
75*50	RPP75/50
110*50	RPP110/50
110*75	RPP110/75
125*110	RPP125/110
160*110	RPP160/110
160*125	RPP160/125



Ramnificatie PP dubla

50*50*50*67	RD50/67
110*50*50*67	RD110/50/50/67
110*50*50*87	RD110/50/50/87
110*110*110*45	RD110/110/110/45
110*110*110*67	RD110/110/110/67
110*110*110*87	RD110/110/110/87



Ramnificatie PP



32/32/67	R32/32/67
32*32*87	R32/32/87
32*32*45	R32/32/45
40/32/67	R40/32/67
40*40*87	R40/40/87
40*40*67	R40/40/67
40*40*45	R40/40/45
40*32*87	R40/32/87
40*32*45	R40/32/45
50*50*87	R50/50/87
50*50*67	R50/50/67
50*50*45	R50/50/45
50*40*87	R50/40/87
50*40*45	R50/40/45

Ramnificatie PP



75/75/67	R75/75/67
75/40/67	R75/40/67
75*75*87	R75/75/87
75*75*45	R75/75/45
75*50*87	R75/50/87
75*50*67	R75/50/67
75*50*45	R75/50/45
75*40*87	R75/40/87
75*40*45	R75/40/45
110*75*87	R110/75/87
110*75*67	R110/75/67
110*75*45	R110/75/45
110*50*87	R110/50/87
110*50*67	R110/50/67
110*50*45	R110/50/45
110*40*87	R110/40/87
110*40*67	R110/40/67
110*40*45	R110/40/45
110*110*87	R110/110/87
110*110*67	R110/110/67
110*110*45	R110/110/45
110/110*87	17502011087
110/110*45	17502011045
125*125*90	R125/125/90
125*125*45	R125/125/45
125*110*87	R125/110/87
125*110*45	R125/110/45
160/110/87	R160/110/87
160/110/45	R160/110/45
160*160*87	R160/160/87
160*160*45	R160/160/45

Ramnificatie PP



32/32/45	17502003245
40/40/45	17502004045
50/50/87	17502005087
50/50/45	17502005045
50/40/45	17502105045
110*50*50*45	R110/50/50*45
110*50*50*67	15062911067
110*110*110*67	15062511067

Cot PP



32*87	CPP32/87	75*45	CPP75/45
32*67	CPP32/67	75*30	CPP75/30
32*45	CPP32/45	75*15	CPP75/15
32*30	CPP32/30	110*87	CPP110/87
32*15	CPP32/15	110*67	CPP110/67
40*87	CPP40/87	110*45	CPP110/45
40*67	CPP40/67	110*30	CPP110/30
40*45	CPP40/45	110*15	CPP110/15
40*30	CPP40/30	125*87	CPP125/87
40*15	CPP40/15	125*67	CPP125*67
50*87	CPP50/87	125*45	CPP125/45
50*67	CPP50/67	160*87	CPP160/87
50*45	CPP50/45	160*45	CPP160/45
50*30	CPP50/30		
50*15	CPP50/15		
75*87	CPP75/87		
75*67	CPP75/67		

Curba tehnica

32X45 24-32	CTPP32
40X46 24-32	CTPP40



Lubrifiant mufe

150GR	LM150
250 GR	LM250



Conector dilatatie Ignifugat



Conector redus



40/32 CRPP40/32
50/40 CRPP50/40

Conector PP ignifugat Fonta

D50 CIPP50
D75 CIPP75
D110 CIPP110
D125 CIPP125



Aerator PP cu membrana

32/40/50 17040003250
50/75/110 17040005011



Conector PP fonta
INEL/GARN.DUBLA



D75 L 169MM 15300707501
D110 L170MM 15300711000

D75 15690307500
D125 15690712500

Capac PP



32 CPP32
40 CPP40
50 CPP50
75 CPP75
110 CPP110

Conector PP TEHNIC
D40



15181720040

Adaptor reductie excentrica

32/40 ARPP32/40
40/50 ARPP40/50
50/75 ARPP50/75



**MUFA FONO
4SILENCE**



D50 mm
D110 mm

**ȚEAVĂ
FONOABSORBANTĂ
4SILENCE**



D110x5,4 L=250mm
D110x5,4 L=500mm
D110x5,4 L=1000mm
D110x5,4 L=2000mm
D110x5,4 L=3000mm
D50x4 L=250mm
D50x4 L=500mm
D50x4 L=1000mm
D50x4 L=2000mm

D50x3 L=1000mm
D110x3,2 L=2000mm
D110x3,2 L=3000mm
D50x3 L=500mm
D50x3 L=2000mm
D50x3 L=500mm

**CURBĂ
FONOABSORBANTĂ
4SILENCE 90°**



D50
D110

**RAMIFICAȚIE
FONOABSORBANTĂ
4SILENCE LA 45°**



D110x110mm
D110x50mm
D50x50mm

**PIESĂ DE INSPECȚIE
FONOABSORBANTĂ
4SILENCE**



D110mm

**CURBĂ
FONOABSORBANTĂ
4SILENCE 45°**



D50
D110

**RAMIFICAȚIE
FONOABSORBANTĂ
4SILENCE LA 90°**



D110x110mm
D50x50mm
D110x110mm

**DOP
FONOABSORBANT
4SILENCE**



D110mm



ȚEVI DE TUBARE (PUȚURI)

L=5m

R8	R10	R16
D114	D90	D75
D140	D114	D90
D160	D125	D125
D180	D140	D140
D200	D160	D160
D225	D180	D180
D250	D200	D200
D280	D225	D225
D330	D250	D250
D400	D280	D280
	D330	D330
	D400	

FILTRU PUŢ APĂ



L=5m

R8

D114
D140
D160
D180
D200
D225
D250
D280
D330
D400

R10

D90
D114
D125
D140
D160
D180
D200
D225
D250
D280
D330
D400

R16

D90
D125
D140
D160
D180
D200
D225
D250
D280
D330

VÂRF COLOANĂ PUŢ

D90
D114
D125
D140
D160
D180
D200
D225
D250
D330



DOP COLOANĂ PUŢ

D90
D114
D125
D140
D160
D180
D200
D225
D250
D330





APOMETRU

APA CALDA CMJMC2
APA RECE CMJMR2

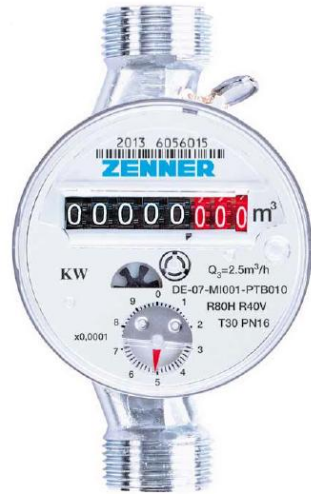

APOMETRU MULTIJET
APARTAMENT

DN20 CMJM20
DN 15 CNT15



APOMETRU MULTIJET
CLASA C

DN15 CNT15C
DN20 CNT20C



APOMETRU MULTIJET
MTK-S DN20 USCAT
CNT20MTK

CLASA C CNT20S



APOMETRU MULTIJET
DN25

CNT25



Ceas pentru butelie cu
reglaj manual

15359



Ceas pentru butelie

14519



KIT ceas butelie

1.5 M - KKR27
2 M - KKS27



Regulator gaz cu filtru

Cod produs 1/2 - 40031
3/4 - 40032



Furtun pentru butelie din
PVC 50M

5020450



Detector gaz metan CD64-
CH4

Dimensiuni: 130 x 92 x 32 mm
Alimentare: 220 V
Curent absorbit: 15 mA
D0000 (fara fir)
D0001 (cu fir)



Kit detector gaze complet
CD64 compus din
electrovalva din alama si
detector.

Electrovalva 3/4" simplu: KDE00
3/4" cu fir: KDE01
1" simplu: KDE02
1" cu fir: KDE03
1/2": KDE08



Contor gaz (membrana)

G4 1 1/4" 6m3/h Interax 110: 50401
G6 1 1/4" 10m3/h Interax 250: 50402
G10 2" 16m3/h interax280: 50402A
G25 1/2" 40m3/h interax355: 50404



Stabilizator gaz 1/2"

40000A



Presostat

R02510



TERMOMANOMETRU
RADIAL D80
10 BARI

1572010



MANOMETRU RADIAL

D63 x 1/4" 0-6BARI : 158206
D50 x 1/4" 0-6 BARI : 159406
D50 x 1/4" 0-16 BARI: 159816



MANOMETRU AXIAL

D50 x 1/4" 0-6 bari : 159706
D63 x 1/4" 0-10 BARI : 159210
D50 x 1/4" 0-16 BARI :
159516



TERMOSTAT IMERSIE DE
CONTACT 0-90 GRADE

R03088



TERMOSTAT DE CONTACT
20-90 GRADE

R03037

BURLANE, JGHEABURI SI ACCESORII



BURLAN PVC D80 3M
BORDO

B80/3B



BURLAN PVC D80 3M
MARO

B80/3M



BRATARA BURLAN PVC D80
BORDO

BB80B



COT PVC D80 BORDO

C80/67B - 67
C80/87B - 87



COT SCURGERE 87 D80
BORDO

CS87/80B



JGHEAB CLASSIC PVC
3M BORDEAU

JC3B



JGHEAB CLASSIC PVC
3M MARO

JC3M



BRATARA BURLAN PVC D80
MARO

BB80M



COT PVC D80 MARO

CD80/67M - 67
CD80/87M - 87



COT SCURGERE 87 D80
MARO

CS87/80M

ACCESORII JGHEABURI SI BURLANE

NFG
TRADE
SOLUTII COMPLETE
PENTRU CASA TA



MUFA D80 BORDO
M80B



RAMIFICATIE BURLAN D80
67 BORDO
RB80/67B



COLIER FIXARE JGHEAB
CLASSIC BORDO
CFJCB



COLTAR JGHEAB 90
CLASSIC BORDO - CJ90CB



IMBINARE JGHEAB
CLASSIC BORDO - IJCB



MARO - CJ90CM



MARO - IJCM



MUFA D80 MARO
M80M



RAMIFICATIE BURLAN D80
67 MARO
RB80/67M



COLIER FIXARE JGHEAB
CLASSIC MARO
CFJCM

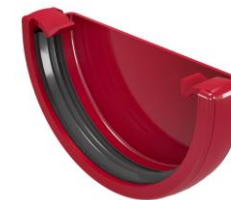

CAPAC JGHEAB CLASSIC
BORDO - CJCB



RACORD JGHEAB BURLAN
CLASSIC BORDO - RJBCB

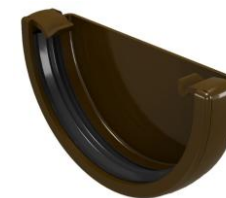

MARO - CJCM



MARO - IJCM



Statie dezinfecție aquaPUR UV
SDE-025 1x25W Q1.4mc/h
SDE-055 1x55W Q2.7mc/h



Stație dedurizare cu BY-PASS
SOFT 10 CAB Q=0,8mc/h SARE
23KG
SOFT 18 CAB Q=1,5mc/h SARE
43KG



Stație dedurizare cu BY-PASS
SOFT 25 CAB Q=2,0mc/h sare 62
kg



Stație dedurizare cu BY-PASS
SOFT 12,5 CAB LOT Q1MC/H



Stație dedurizare cu BY-PASS
SOFT 25 CAB LOTUS Q2MC/H



Pastile de sare pentru statia de
dedurizare 25kg



Stație dedurizare cu BY-PASS
SOFT 18 SIMPLEX Q1,5MC/H



Stație dedurizare cu BY-PASS
SOFT 10 SIMPLEX Q0,8MC/H



Stație dedurizare cu BY-PASS
SOFT 25 SIMPLEX Q2MC/H
SOFT 37 SIMPLEX Q=2,5MC
SOFT 50 SIMPLEX Q=3MC/H



Stație dedurizare cu BY-PASS
SOFT 75 SIMPLEX Q=3,5mc/h
SOFT 100 SIMPLEX Q=4,0mc/h
SOFT 125 SIMPLEX Q=5,0mc/h
SOFT 175 SIMPLEX Q=6,0mc/h
SOFT 225 SIMPLEX Q=7,0mc/h



Stație dezinfectie
aquaPUR UV

SOFT 25 TWIN Q=1,3mc/h
SOFT 37 TWIN Q=1,8mc/h
SOFT 50 TWIN Q=2,4mc/h
SOFT 75 TWIN Q=3,5mc/h
SOFT 100/ 125/ 175/ 225.



Stație osmoză inversă cu
mineralizare și pompa



Stație osmoză inversă cu
mineralizare



Stație osmoză inversă cu
pompa
SI 600GPD Q=1,58L/min



Membrană osmoză inversă
50GPD



Stație osmoză inversă cu
QUICK mineralizare



Stație tratare cu BY-PASS
MIX 25 CAB Q=1,2mc/h
MIX 37 SIM Q=1,4mc/h



Stație tratare cu BY-PASS
MIX 50 SIM Q=1,8MC/H



Sistem ultrafiltrare apă
PUR4 11 UF
Cu baterie



Sistem ultrafiltrare apă
PUR4 11 UF
Cu baterie cu 3 căi



Set 3 cartușe filtrante
PUR3 10



Set 2 cartușe filtrante
PUR2 10



Dozator apă pe podea
3 filtre H3HNC



Dozator apă birou S3HNC



Kit dozator apă
M105U CO2 montare
chiuveta



Kit dozator apă
M105U CO2 montare birou



Sistem filtrare apă PUR2 10
Cu baterie



Sistem filtrare apă PUR2 10
UF
Cu baterie



Sistem filtrare apă PUR3 10
Cu baterie



Sistem filtrare apă PUR3 10
UF cu baterie
Cap.4



Rezervor apă*
V300L H960mm
L=l= 600 mm



Rezervor apă*
V500L H=1600mm
L=l= 600 mm



Rezervor apă*
V750L H1840mm
L=l= 600 mm



Sistem de stocare,
pompare și filtrare*
L=l= 690 mm

300 (260L)
500 (480L)
750 (700L)



Rezervor apă oval
V1000L

Rezervor cilindric vertical

Vertical cylindrical tank

Резервуар цилиндрический вертикальный

Volum volume/объем [l]	D [mm]	H ³ [mm]	D capac D cap/D крышка [mm]	Masa weight/масса [kg]	Cod code/код
500 ¹	780	1300	310	18	49020105000
1000 ²	800	2230	310	32	49020110000



¹ Se fabrică cu un racord de 1" la partea inferioară

² Se fabrică cu racorduri:
-1x 1 1/2" și 1 x 1" la partea inferioară;
-1 x 1 1/2" la partea superioară

³ Htot: înălțimea totală, inclusiv capac

Rezervor cilindric vertical pentru instalații incendiu

Vertical cylindrical tank for fire networks

Резервуар цилиндрический вертикальный

Volum volume/ объем [l]	D [mm]	H ² [mm]	D capac D cap/D крышка [mm]	Masa weight/масса [kg]	Cod code/код
5000 ¹	1936	2050	400	130	49020150000
6500 ¹	1936	2500	400	150	49020170000

¹ Se fabrică cu racorduri:

- 2 x 2" la partea inferioară și 1 x 2" la partea superioară

² Htot: înălțimea totală, fără capac



Fose septice



aqua
clean

Model	Volum [litri]	Dimensiuni (LxIxH) [mm]	Conexiuni intrare/ieșire	Zone de acces	Masa [kg]	Cod code/код
Fosă septică 3500	3000	2650 × 1400 × 1760	Ø 110 mm	2 x 630 mm	190	48601035000
Fosă septică 5000	4700	2760 × 1760 × 1930	Ø 110 mm	2 x 630 mm	300	48601050000

Standard de conformitate : SR EN 12566-1:2000/A1:2003

OPȚIONAL (pentru reglarea poziției capacelor la cotă)

Denumire accesoriu	Cod code/код
Prelungire L=600 mm pentru stație epurare și rezervor 5000L	48710000604
Piesă fixare prelungire cămin	47901000125
Garnitură etanșare cămin DN640	47901000116

Destinație:

În fosele septice, apele menajere se limpezesc parțial și apoi sunt evacuate în puțuri absorbante sau drenuri, iar nămolul depus pe fundul fosei fermentează timp îndelungat 6 luni, transformându-se din punct de vedere chimic până la mineralizare prin acțiunea organismelor vii și este îndepărtat după acest interval prin vidanșare. Fosele septice degajă puternic gaze de mlaștini, amoniac (NH₃), bioxid de carbon (CO₂), hidrogen sulfurat (H₂S) și foarte puțin metan (CH₄), de aceea este necesară o aerisire efecă.

Separatoare de hidrocarburi aquaClean din polietilenă cu montare subterană

aquaClean polyethylene hydrocarbons separators with underground installation
Отделители углеводородов aquaClean из полиэтилена с подземным монтажом

Tip type/тип	Formă shape/форма	Cod code/код
NS 3	cilindric orizontal horizontal cylindrical горизонтальный цилиндр	48930000300
NS 6		48930000600
NS 10		48930001000



Sistem avertizare hidrocarburi

Hydrocarbons Warning System
Система предупреждения углеродов

Tip type/тип	Cod code/код
Sistem avertizare hidrocarburi Hydrocarbons Warning System Система предупреждения углеродов	48810000000



Separatoare de grăsimi aquaClean din polietilenă cu montare subterană

aquaClean polyethylene grease separators with underground installation

Отделители жиров aquaClean из полиэтилена с подземным монтажом

Montare în zonă necarosabilă

Installation in the pedestrian area

Не для установки под проезжей частью

Tip type/тип	Formă shape/форма	Cod code/код
NG 2	cilindric vertical vertical cylindrical вертикальный цилиндр	48910000200
NG 4		48910000400
NG 4	cilindric orizontal horizontal cylindrical горизонтальный цилиндр	48910000401
NG 10		48910001000
NG 15		48910001500



NG 2 / NG 4



NG 4



NG 10 / NG 15

Montare în zona carosabilă

Installation in the carriageable area

Для установки под проезжей частью

Tip type/тип	Formă shape/форма	Cod code/код
NG 2	cilindric vertical vertical cylindrical вертикальный цилиндр	48920000200
NG 4		48920000400

Separator grăsimi aquaClean cu montare supraterană NG 0.3

aquaClean grease remover NG 0.3 with elevated mounting

Сепаратор жиров aquaClean с подземным креплением NG 0.3

Tip type/тип	Cod code/код
Separator grăsimi aquaClean NG 0.3 aquaClean grease remover NG 0.3 сепаратор жиров aquaClean NG 0.3	48820000030
Sac de nămol pentru separator grăsimi NG 0.3 sludge bag for grease remover NG 0.3 мешок для грязи для сепаратора жиров NG 0.3	48810000001



SBR 1/6 LE și SBR 7/12 LE

Stații de epurare ape uzate menajere până la 1000, respectiv 1500 litri/zi



Denumire produs	Model	Debit maxim [litri/zi]	CB05 [kg/zi]	Nr. bazine	Dimensiune bazin(e) [mm]	Cod code/код
SBR 1/6 LE	S5	1000	0,3	1	2650 x 1400 x 1760	48600000005
SBR 7/12 LE	S10	1500	0,6	1	2760 x 1760 x 1930*	48600000008

*la această cotă se adaugă 600 mm, înălțimea piesei de reglare
Puterea instalată = 300 W
Consum energetic 500 - 2000 W/zi în funcție de încărcare

INCALZIRE IN PARDOSEALA

SISTEM VALROM – PEXKIT

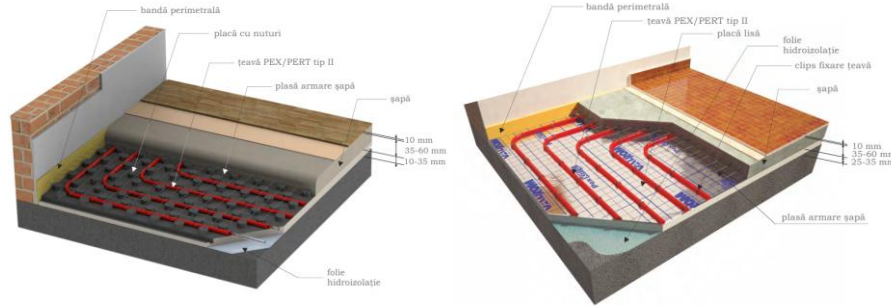

COMPONENTE

1. Teava

PEX cu/fara barieră de oxigen (NATUR/ROSIE)

SAU

PERT - tip II cu / fără barieră de oxigen (NATUR/ROSIE)

2. Suport

PLACA TERMOIZOLANTA NUTURI NEAGRA
30 kg/mc 1000x500x39/
25 kg/mc 1000x500x57

SAU

PLACA TAKER TERMOIZOLANTA RULOU
10000X1000X25 10 mp (in stoc)/
10000X1000X35 10 mp (la comanda)

3. Kit amestec

KIT AMESTEC PexKIT INCALZIRE PARDOSEALA MINI 1 - cu pompa GRUNDFOS cu turatie variabila

5. Automatizare

4. Alte componente



SISTEM TERAPLAST – NeoTer

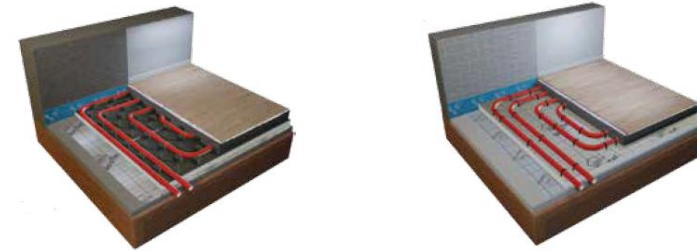

COMPONENTE

1. Teava

NEOPE-XA cu barieră de oxygen polietilenă reticulată cu peroxizi

Diametre: 16 x 2,0 mm, 17 x 2,0 mm, 20 x 2 mm, 25 x 2,3 mm, 32 x 2,9 mm
L: 4 m, 50 m, 100 m, 250 m, 600 m
roșu - 16 x 2,0 mm, 17 x 2,0 mm,
natur - 20 x 2 mm, 25 x 2,3 mm, 32 x 2,9 mm

NEOPE-RT II cu barieră de oxygen polietilenă „raised temperature”.

grosimi de țevă: 16 x 2,0 mm, 17 x 2,0 mm
lungime: 100 m, 250 m, 600 m
culoare: natur

2. Suport

PLACA CU NUTURI TERMO NEAGRA
1200x710x20 mm

SAU

PLACA TAKER EPS
100/ 25 mm 1*10M

3. Kit amestec

KIT AMESTEC NEOTER
WILO 130 MM
KIT AMESTEC NEOTER IBO 130 MM

4. Alte componente



Dimensionare gratuita in baza planului locuintei/Optimizare colaci in vederea reducerii pierderilor
Asistenta tehnica la montaj/garantie extinsa in baza documentatiei solicitate

Automatizare:



Țevi PE-X / PE-RT și fittinguri pentru radiatoare și distribuție apă caldă/apă rece

Tubulatură PE-Xa cu barieră de oxigen

D x s [mm]	Colac [m]		Cod
16 x 2,2	100	25	PEX012241016100
20 x 2,8	100	19	PEX012241020100
25 x 3,5	100	12	PEX012241025100
32 x 4,4	50	10	PEX012241032050

D - Diametrul extern

s - Grosime

Material: PE-Xa - polietilenă reticulată - metoda cu peroxizi

Conform standard: EN ISO 15875-2

Barieră de oxigen (EVOH): DIN 4726



Tub flexibil de protecție

Culoare	D [mm]	D _{teavă} [mm]	Colac [m]	Cod
roșu	25	16 x 2,2	50	10700025051
	32	20 x 2,8	50	10700032051
	40	25 x 3,5	25	10700040026
albastru	25	16 x 2,2	50	10700025052
	32	20 x 2,8	50	10700032052
	40	25 x 3,5	25	10700040027

D - Diametrul extern

Se utilizează pentru protecția țevii

Tubulatură PE-RT tip II cu barieră de oxigen

D x s [mm]	Colac [m]		Cod
16 x 2,2	100	20	PEX002140016100
16 x 2,2	200	-	PEX002140016200
20 x 2,8	100	14	PEX002140020100
20 x 2,8	200	-	PEX002140020200
25 x 3,5	100	12	PEX002140025100
32 x 4,4	50	10	PEX002140032050

D - Diametrul extern

s - Grosime

Material: PE-RT

Conform standard: EN ISO 22391-2

Barieră de oxigen (EVOH): DIN 4726



Cârlig fixare țevă

Model	D [mm]	d [mm]	L [mm]		Cod
Simpleu	16-25	97	43	2000	64192000116
Dublu	16-25	102	77	1300	64192000216



RADIATOR TIP 11

400	500	600	700	800	900	1000	1100	1200	1300	1400	1500	1600	1800	2000	2200	2400	2600	2800	3000
-----	-----	-----	-----	-----	-----	------	------	------	------	------	------	------	------	------	------	------	------	------	------

300
400
500
600
900



ferroli
RADROM
KORADO

RADIATOR TIP 22

400	500	600	700	800	900	1000	1100	1200	1300	1400	1500	1600	1800	2000	2200	2400	2600	2800	3000
-----	-----	-----	-----	-----	-----	------	------	------	------	------	------	------	------	------	------	------	------	------	------

300
400
500
600
900



ferroli
RADROM
KORADO

RADIATOR TIP 33

400	500	600	700	800	900	1000	1100	1200	1300	1400	1500	1600	1800	2000	2200	2400	2600	2800	3000
-----	-----	-----	-----	-----	-----	------	------	------	------	------	------	------	------	------	------	------	------	------	------

300
400
500
600
900



ferroli
RADROM
KORADO

Calorifere de tip Port-prosop

1800
1600
1500
1400
1200
1100
1000
800
700

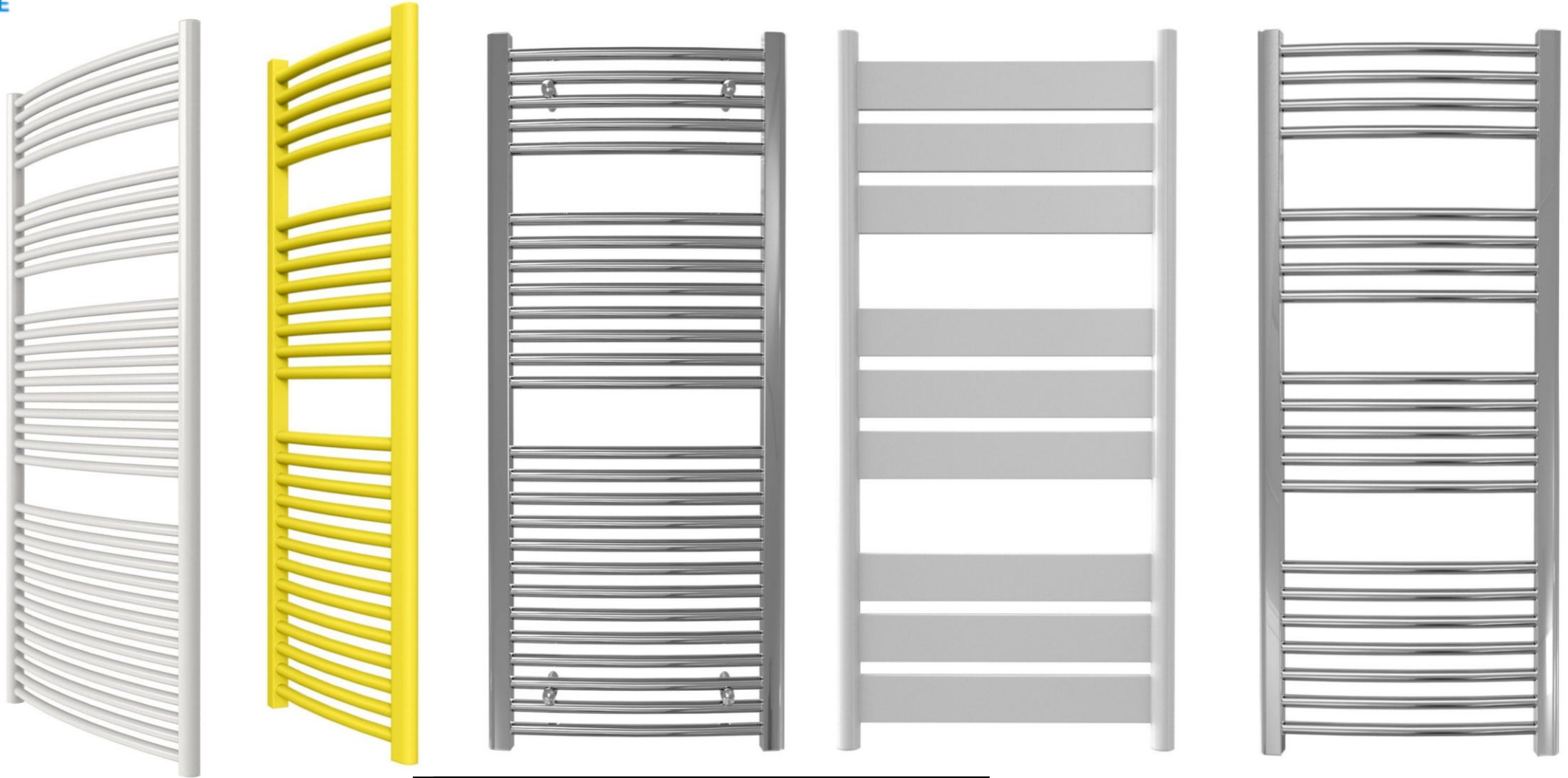

400	450	500	550	600
-----	-----	-----	-----	-----

*Caloriferele sunt disponibile în mai multe culori.

Calorifere Decorative

Înălțimi disponibile între 315-2000 mm



Lățimi disponibile între 89 - 800 mm



*Caloriferele sunt disponibile în mai multe culori.

*Caloriferele sunt disponibile în mai multe culori.

Calorifere Decorative

Înălțimi disponibile între 315-2000 mm

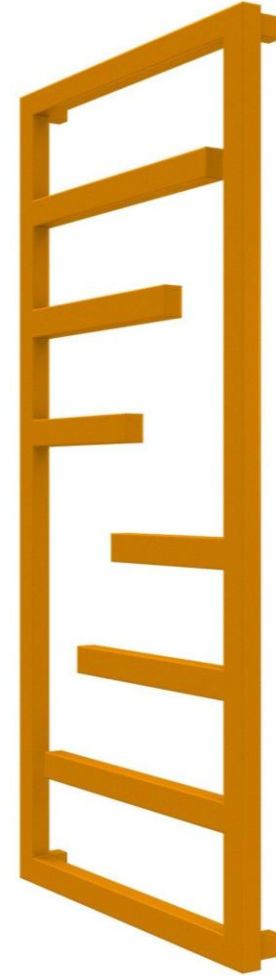

Lățimi disponibile între 89 - 800 mm

ALTEAS ONE NET

Vârful gamei.
Generația viitoare de centrale termice în condensare pentru control complet al încălzirii, cu conectivitate inteligentă. Noul sistem de performanță îmbină 4 Tehnologii într-un singur produs. Panou frontal din sticlă ultraSafe.



BOILER ELECTRIC VELIS

Performanța de top

- tehnologie cu doua rezervoare;
- functia ECO EVO actionata de CoreTECH: economie de energie de pana la 20%.
- reglare digitala a temperaturii;
- afisaj cu LED-uri;
- adancime de numai 27 cm si instalare in doua pozitii (verticala sau orizontala).



POMPĂ DE CĂLDRURĂ NIMBUS PLUS



GENUS ONE SYSTEM

Centrală termică în condensare doar pentru încălzire, pentru crearea de sisteme (hibrid, solar, centrală cu rezervor extern). Este construită pe un nou sistem cu 4 tehnologii pentru o performanță exclusivă.



AER CONDIȚIONAT INVERTER PRIOS 50

Clasa A++
Ultra Silent
Consum 1 W in modul Stand By
Garantie: 3 ani
Functii Follow Me, AUTO RESTART, MEMORY,
Wi-Fi ready
Agent frigorific R32



BOILER ELECTRIC ANDRIS RS 15 Litri



CENTRALĂ TERMICĂ

Functionare pe gaz, pentru incalzire si preparare a apei calda menajere.

Nou panou de afisaj care include un manometru front si butoane din silicon pentru regimul de functionare, temperatura a apei, reset si temperatura de incalzire.



CENTRALĂ TERMICĂ CARES 30

Centralele termice murale in condensatie din gama Cares S de la Ariston reprezinta o solutie eficienta atat pentru furnizarea de apa calda menajera, cat si pentru incalzirea spatiilor rezidentiale. Cazanul Cares se distinge prin consumul redus fata de centralele din generatiile anterioare, gratie tehnologiei in condensatie.



LYDOS EVO 80V BOILER ELECTRIC

Design modern, afisaj cu LED-uri si functii multiple, gandite special pentru fiabilitate si confort in utilizare.

Boilerul este realizat din materiale de calitate si beneficiaza de tehnologie de ultima generatie.

Se preteaza la a fi amplasat in incaperi de dimensiuni mari.



BOILER ELECTRIC REGENT

Caracteristici:

- Izolație ecologică poliuretan
- Anod de magneziu supradimensionat
- Element de încălzire din cupru
- Reglarea temperaturii prin butonul frontal
- Rezervor interior emailat, testat la 16 bari
- Supapa de siguranță pentru controlul presiunii testata la 8 bari
- Flanșa cu 4 șuruburi



**CENTRALĂ BLUEHELIX MAXIMA 28C +
TERMOSTAT CONNECT**

LED multicolor.
Display-ul de 7".
Termostat gestionat prin
iOS sau Android App.
Clasa energetica A+



**CAZAN OTEL PE PELEȚI BIOPELLET
PRO**

Ardere automatizată
a peleților.
Controlul arderii este
optimizat folosind
un algoritm de modulare,
care scade automat dozarea
peleților și a aerului pe
măsură ce cazanul se
apropie de temperatura dorită.



ECO HEAT – COLECTOR SOLAR PRESURIZAT

Principiul de funcționare al
încalzitului solar presurizat
se bazează pe schimbul de
energie dintre colector și
apa din rezervor.
Pe măsură ce tuburile vidate
absorb energia solară,
țeava heatpipe va transfera
căldura către apa din rezervor.
În acest fel apa rece este
încălzită în mod constant.

EcoHeat
Colector Solar Presurizat



CAZAN FSB PRO

Construcție eficientă
cu 3 drumuri de fum
pentru funcționare cu
brichete, tocătură
lemnoasă, orice fel
de resturi și
deșeuri vegetale,
agricole,
forestiere, silvice, lemn
și cărbune cu puterea
calorifică mai
mare de 15 MJ/kg.



REZERVOR DE ACUMULARE (PUFFER)

Înmagazinează energia
termica furnizata de cazanele
pe combustibil gazos sau
lichid, si minimizeaza
pornirile arzatorului, respectiv
echilibreaza regimul de furnizare
a energiei termice a
cazanelor pe lem
ne, aschii si peleti.



POMPĂ DE CALDURA OMNIA

IDEALĂ PENTRU TOATE TIPURILE DE SISTEM

-încălzire în
pardoseală,
-ventiloconvectoare,
-radiatoare,
-producție de apă
menajeră (ACM)

Prin intermediul
unui boiler extern



CENTRALĂ BLUEHELIX ALPHA 24

Schimbător de căldură principal din oțel inoxidabil rezistent la depueri și ușor de curățat.

Arzător de înaltă eficiență cu emisii reduse.

Ventilator cu turație variabilă.

Schimbator de căldură în plăci pentru producție instantanee.
Pompă electronică clasa A.



TERMOȘEMINEU PE PELEȚI MIRANO N24

Automatizat, pentru încălzire centralizată, complet echipat cu pompa încălzire, vas de expansiune, supapa de siguranță, termostat de siguranță, panou de comandă digital, autocurățare prin debit de aer mare, buncar peleti și tavita de cenușă detașabilă. Controlul arderii este optimizat folosind un algoritm de modulare, care scade automat dozarea peletilor și a aerului pe măsura ce cazanul se apropie de temperatura dorită.



CAZAN DE FONTĂ PE PELEȚI SUNPELLET 4

Camera de ardere este complet imersată, ceea ce asigură o lungă durată de viață și randament ridicat.

Cazan, arzător, rezervor de peleti, șneț și termostat de siguranță arzător.



KIT PANOU SOLAR



AER CONDITIONAT AMBRA

Aparat de aer condiționat sistem split echipate cu inverter DC, constituite dintr-o unitate interioară de perete și una exterioară. Posibilitate de gestionare la distanță prin aplicație dedicată (iOS și Android) pe Smartphone sau tabletă, necesită conexiunea aparatului la rețeaua WI-FI.



TERMOȘEMINEU MIRANO H

Funcționează pe baza de combustibil solid (lemn, carbune). Este destinat încălzirii centralizate prin intermediul radiatoarelor, creând totodată o ambianță plăcută în încăpere. Tehnologia modernă de proiectare și fabricație, precum și utilizarea materialelor de calitate, asigură o funcționare eficientă și sigură în condițiile respectării instrucțiunilor de instalare și utilizare.



CENTRALĂ ISOTWIN CONDENS T 35-CS/1

Centrala termica pe combustibil gazos cu boiler incorporat, care ofera utilizatorului un confort deosebit de apa calda menajera. Temperatura apei din boiler se pastreaza constanta, chiar si atunci cand se deschid simultan mai multi robineti.



CENTRALĂ THEMAFAST CONDENS

Beneficiaza de noua tehnologie **FlameFit** ionizatie care adapteaza si optimizeaza functionarea centralei in functie de tipul si calitatea gazului.

Disponibilitate rapide a ACM + stabilitate buna a temperaturii datorita rezervorului integrat de 3L

- Debit ridicat de ACM
- Confort ACM



CENTRALĂ TERMICĂ THELIA CONDENS

Face parte din grupa centralelor cu tehnica condensarii, aparate care sunt mai eficiente si mai silentioase dar si demne de incredere si usor de utilizat.



CENTRALĂ SEMIATEK CONDENS

Soluția optimă pentru încălzire și preparare apă caldă menajeră.

Raport excelent calitate/preț, atât pentru imobile noi, cât și în cazul înlocuirilor

Poate fi adaptată la sistemele de încălzire și de alimentare cu apă caldă existente

Schimbator de caldura din otel inoxidabil



CENTRALĂ TERMICĂ MURALĂ VITODENS 050-W 19KW ACM+AT

Datorită ansamblurilor moderne, cazanul mural în condensatie pe gaz montat pe perete economisește foarte mult spațiu și totodată poate fi instalat și în nișe mici.



POMPĂ DE CĂLDURĂ VITOCAL

Completă;
Structură monobloc;
Formată din: unitate internă
Și unitate externă.



BOILER MONOVALENT VITOCCELL

Rezevorul din otel al boilerului este protejat impotriva coroziunii, cu email in doua straturi Ceraprotect din productie proprie.

Protectie catodica suplimentara este asigurata de anodul de magneziu, anodul pe curent furnizat de o sursa independenta este livrabil ca accesoriu.



CAZAN TERMIC PE LEMNE VITOLINGO

Cazan pe combustibil solid cu functionare pe principiul gazeificarii lemnului, cu o putere nominala de 30 Kw. Permite obtinerea unui grad inalt de eficienta si o ardere redusa in emisii poluante.



CAZAN DIN OȚEL CU ARZĂTOR PE PELETI PLC

O alternativa economica de cazane cu functionare pe peleți.
Cazanul este presurizat, cu schimbator de caldura cu tevi, care ofera suprafata mare de schimb termic la dimensiuni exterioare reduse si functionare optima a arzatorului pe pellet.
Produsul include: cazan, arzator pellet, snec de alimentare si siloz de combustibil.



CAZAN CU FUNCȚIONARE PE COMBUSTIBIL SOLID ECOWOOD PLUS

Cazanul controleaza de asemenea pompa de incalzire, pompa de apa calda si permite conectarea unui termostat de camera. Lipsa de combustibil este detectata automat, iar cazanul intra in regim de asteptare (standby).



CAZAN TERMIC PE LEMNE MCL

Conceput pentru functionarea cu orice tip de combustibil solid cu diametru minim 30mm: lemn, reziduuri agricole, carbuni, brichete, etc.
Este echipat cu ventilator modulant si panou de comanda digital care asigura multiple functii de automatizare a cazanului si a instalatiei



ECOTWIN – CAZAN COMBINAT PE LEMNE ȘI PELETI

Cazanul permite montarea unei uși suplimentare pentru trecerea facila din funcționarea pe lemn la pellet (opțional). În funcție de combustibilul utilizat, se închide ușa: ușa cu clapetă aer la utilizarea lemnului, ușa cu arzător la utilizarea pelletului.
ECOTWIN este oferit ca și centrală completă ce include cazan, arzător pellet, alimentator și siloz pellet. Silozul poate fi ales în trei variante în funcție de autonomia dorită.



Boilere de capacitate mare - cu 2 serpentine/ 1 Serpentina sau FARA Serpentina

- ✓ Izolatie din poliuretan pentru eficienta energetica
- ✓ 2 Anози de magneziu pentru protectia rezervorului si Termometru
- ✓ Flansa pentru interventie facila + Posibilitatea montarii unui kit electric
- ✓ Racord pentru montaj termostat si Sensor Termic
- ✓ O serpentine sau 2 Serpentine cu suprafata mare de schimb termic

Model	Cod TESI	Diametru cu Izolatie	Diametru FARA Izolatie	Greutate	Inaltime
Tesy Boiler 200 Litri	301407	600	600	70.00	1.20 metri
Tesy Boiler 300 Litri	301391	650	650	100.00	1.42 metri
Tesy Boiler 500 Litri	301396	750	750	158.00	1.67 metri
Tesy Boiler 800 Litri	305416	950	750	252.00	1.94 metri
Tesy Boiler 1000 Litri	305428	1010	900	279.00	2 metri
Tesy Boiler 1500 Litri	305417	1200	1000	408.00	2.193 metri
Tesy Boiler 2000 Litri	305431	1300	1100	486.00	2.40 metri

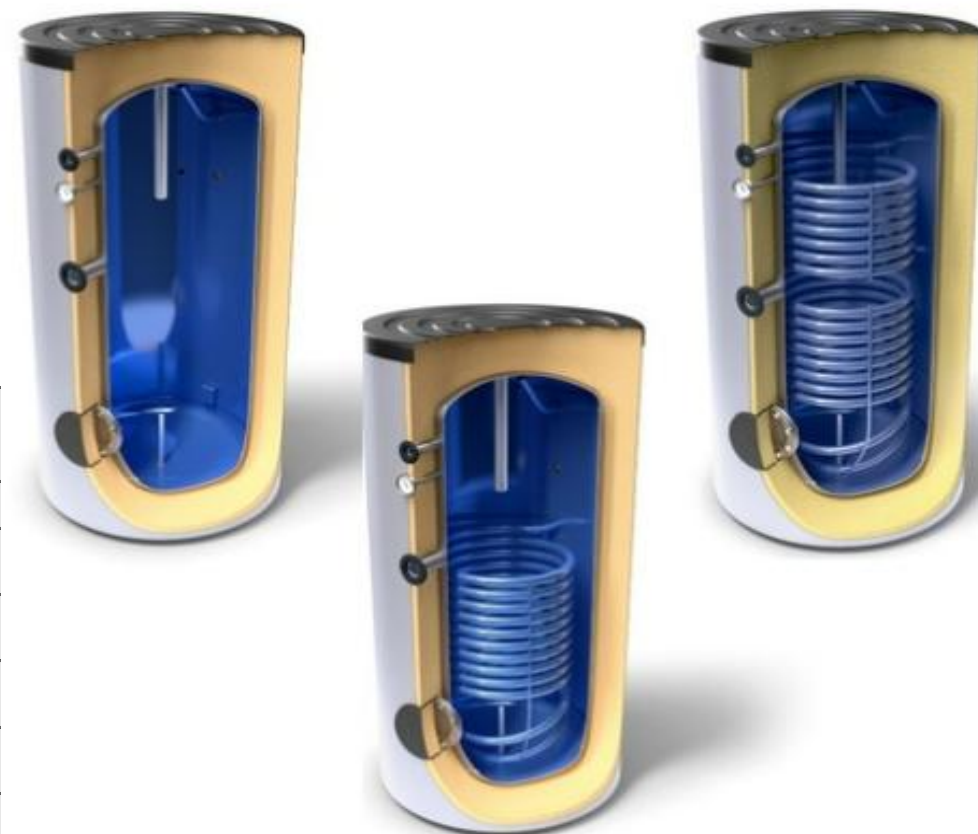

BOILERE Tesy cu 1 Serpentina sau 2 Serpentine pentru Apa Calda Menajera

Boiler cu serpentina eficienta



80 L - 150 L

Boiler cu doua serpentine intercalate

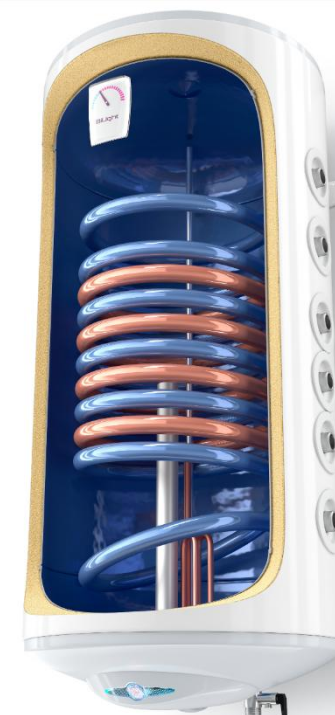

100 L - 150 L

Model	Diametru cu Izolatie	Inaltime
Boiler 80 Litri cu 1 Serpentina	44 cm	84 cm
Boiler 100 Litri cu 1 Serpentina	44 cm	98 cm
Boiler 120 Litri cu 1 Serpentina	44 cm	115 cm
Boiler 150 Litri cu 1 Serpentina	44 cm	131 cm
Boiler 120 Litri cu 2 Serpentine	44 cm	115 cm
Boiler 150 Litri cu 2 Serpentine	44 cm	131 cm

Puffere de capacitate mare - cu 2 serpentine/ 1 Serpentina sau FARA Serpentina

- ✓ Rezervor de acumulare Agent Termic – 3 bar;
- ✓ 8 racorduri de 1.1/2 si 4 pozitii de montaj pentru senzorii termici
- ✓ Izolatie FIXA – RIGIDA pentru capacitati de la 200 la 500 litri
- ✓ Izolatie DETASABILA tip saltea - 800 – 2000 Litri
- ✓ Serpentina SOLARA si TEMRICA
- ✓ Toate modelele cu izolatie rigida pot fi folosite in instalatiile pentru racire active.

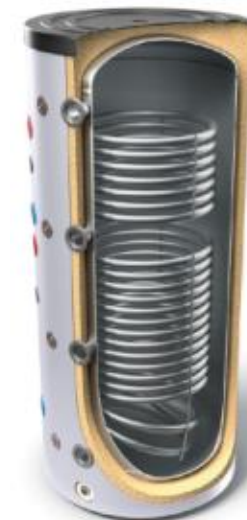

Model	Diametru cu Izolatie	Diametru FARA Izolatie	Greutate	Inaltime
Puffer 200 Litri FARA Serpentina	600	600	70.00	1.20 metri
Puffer 300 Litri FARA Serpentina	650	650	100.00	1.42 metri
Puffer 500 Litri FARA Serpentina/ 1 Serpentina/ 2 Serpentine	750	750	158.00	1.67 metri
Puffer 800 Litri FARA Serpentina/ 1 Serpentina/ 2 Serpentine	950	750	252.00	1.94 metri
Puffer 1000 Litri FARA Serpentina/ 1 Serpentina/ 2 Serpentine	1010	900	279.00	2 metri
Puffer 1500 Litri FARA Serpentina/ 1 Serpentina/ 2 Serpentine	1200	1000	408.00	2.193 metri
Puffer 2000 Litri FARA Serpentina/ 1 Serpentina/ 2 Serpentine	1300	1100	486.00	2.40 metri

TESY

PUFFER Igienic pentru sisteme complexe – Încalzirea CASEI și PEPARARE Apă Caldă Menajeră

Puffere IGIENICE 3 in 1 cu 3 FUNCTII Specifice:

- * FUNCTIE Stocator 500/ 800 sau 1000 Litri Agent Termic Incalzire pentru Pardoseala sau Calorifere
- * FUNCTIE Serpentina Solara/ Serpentina Antigel pentru Panouri Solare
- * FUNCTIE Apa Calda Menajera INSTANT cu Serpentina INOX

- ✓ Debit maxim de apa calda; acumulare agent termic in mod continuu– 1500-1700 l/h
- ✓ Presiune maxima de 8 bar pe serpentina pentru apa calda menajera
- ✓ Temperatura maxima de 95°C in serpentina pentru apa calda menajera
- ✓ 4 Intrari / 4 Iesiri de 1 ½ pentru Centrala Termica/ Pompa de Caldura
- ✓ 4 teci de ½ pentru racordarea senzorilor termici



Cap.5

Model	Diametru cu Izolatie	Diametru FARA Izolatie	Inaltime
Puffere de capacitate mare - cu 2 serpentine/ 1 Serpentina sau FARA Serpentina			
Puffer Igienic 500 Litri cu 1 Serpentina de INOX SI/SAU cu 1 Serpentina SOLARA	750	750	1.69 metri
Puffer Igienic 800 Litri cu 1 Serpentina de INOX SI/SAU cu 1 sau 2 Serpentine SOLARE	950	750	1.95 metri
Puffer Igienic 1000 Litri cu 1 Serpentina de INOX SI/SAU cu 1 sau 2 Serpentine SOLARE	1010	900	2,1 metri

Rezervoare TAMPON pentru pompele de caldura

- ✓ Rezervoare de acumulare 30L, 50l, 80l si 100L capacitate
- ✓ Modele emailate si neemailate
- ✓ Concepute a fi folosite in sistemele cu Pompe de Caldura
- ✓ MONTARE PE PERETE
- ✓ 5 ani GARANTIE pentru rezervor
- ✓ Elemente anticondens pe intrarile si iesirile din partile inferioare si superioare
- ✓ Jacheta din metal , Culoare gri/ alba



Modele:	Presiune de lucru [Bar]	Clasa ErP	suprafata interioara	Domeniu de utilizare:	Locul de instalare
30 L	6	B	neemailata	Acumulare agent termic in instalatiile cu pompa de caldura.	Case unifamiliale
50 L	6	B			
80 L	6	B			
100 L	6	B			
50 L EMAILAT	6	B	emailata		
80 L EMAILAT	6	B			



Ideal Standard

IdealStream & Cerafine O

Baterie lavoar cu ventil
IdealStream
B1262AA



Baterie lebada bucatarie
IdealStream
B1488AA



Baterie bideu
IdealStream
B1264AA



Baterie lavoar
Cerafine O
BC699AA



Baterie cada
Cerafine O
BC500AA



Baterie cada
IdealStream
B1487AA



Baterie bucatarie
IdealStream
B1267AA



Baterie lavoar lebada
IdealStream
B1263AA



Baterie bideu
Cerafine O
BC705AA

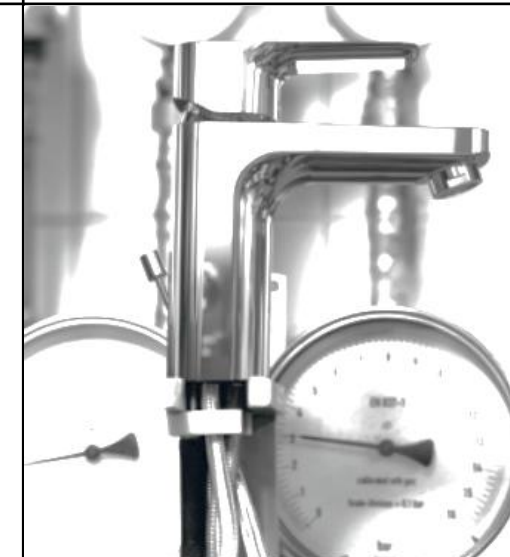



Ideal Standard

Cerabase

Baterie lavoar
Cerabase
BC827AA



Baterie lavoar cu dus
igienic Cerabase
BC834AA



Baterie lavoar lebada
Cerabase
BC835AA



Baterie bideu cu ventil
Cerabase
BC840AA



Baterie dus
Cerabase
BC842AA



Baterie bucatarie
Cerabase
BD431AA



Baterie lebada
Cerabase
BC844AA



Baterie de perete
Cerabase
BD488AA



Baterie cu dus
Cerabase
BD060AA



Baterie cada cu set dus
Cerabase
BD600AA



Baterie lavoar ARS
2420350



Baterie inalta lavoar ARS
2420360



Baterie cadă ARS
2420370



Baterie duș ARS
2420380



Coloana dus ARS
2420150



Baterie lavoar
ARS BLACK
2420400



Baterie lavoar înaltă
ARS BLACK
2420410



Baterie cadă
ARS BLACK
2420420



Baterie duș ARS BLACK
2420430



Coloana dus ARS BLACK
2420160



Baterie lavoar DECOR
2420600



Baterie înaltă lavoar
DECOR
2420610



Baterie cadă DECOR
Set dus inclus
2420620



Baterie duș DECOR
Set dus inclus
2420630



Coloană duș LOFT
2455740



Baterie lavoar
DECOR BLACK&GOLD
2420700



Baterie înaltă lavoar
DECOR BLACK&GOLD
2420710



Baterie cadă
DECOR BLACK&GOLD
Set dus inclus
2420720



Baterie duș
DECOR BLACK&GOLD
Set dus inclus
2420730



Baterie lavoar LOFT
2454910



Baterie înaltă lavoar
LOFT
2454730



Baterie cadă LOFT
2454930



Baterie lavoar TUBE
2454810



Baterie înaltă lavoar
TUBE
2454820



Baterie bideu LOFT
2454950



Baterie bucătărie LOFT
2454960



Baterie dus LOFT
2454940



Baterie cadă TUBE
2454830



Baterie duș TUBE
2454840



Baterie lavoar
ARS BRUSHED GOLD
2420450



Baterie înaltă lavoar
ARS BRUSHED GOLD
2420460



Baterie cadă
ARS BRUSHED GOLD
2420470



Coloana dus
ARS BRUSHED GOLD
2420170



Coloana dus
LOFT BLACK
2455750



Baterie lavoar
ARS SATIN COPPER
2420500



Baterie înaltă lavoar
ARS SATIN COPPER
2420510



Baterie duș
ARS BRUSHED GOLD
2420480



Baterie lavoar
LOFT GOLD
2455800



Baterie înaltă lavoar
LOFT GOLD
2455830



Baterie cadă LOFT GOLD
2455810



Baterie duș LOFT GOLD
2455820

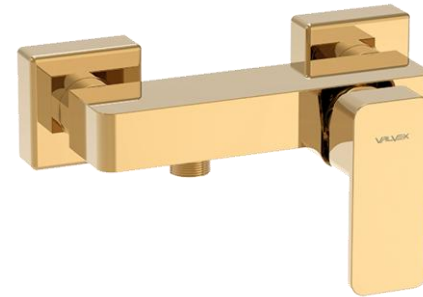

Coloană duș LOFT GOLD
2455670



Baterie lavoar
LOFT BLACK
2455900



Baterie înaltă lavoar
LOFT BLACK
2455910



Baterie cadă
LOFT BLACK
2455920



Baterie duș
LOFT BLACK
2455930





ECO
Baterie pentru cadă/duș
cu montaj pe perete

2406920



CLASS
Baterie pentru lavoar cu
țeavă scurtă, cu montaj
pe perete

2446010



CLASS
Baterie pentru bucătărie
cu montaj pe perete

2446020



CLASS
Baterie pentru
cadă/lavoar si duș

2446050



CLASS
Baterie stative pentru lavoar

2446200



FLEXI
Baterie de bucătărie stativă
cu mâner lateral

2444100



CLASS
Baterie pentru
cadă/duș cu montaj pe perete

2446030

Baterie lavoar C1

BML



Baterie cadă C3

BMC



Baterie duș C7

BMCD



Baterie cadă teava
medie TM CA11

BMCTM



Baterie stativa C17

BMS



Baterie lebada C20

BMLE



Baterie bucătărie
C6

BMB



Baterie de perete
pipa lunga TL C8

BMPTL



Baterie de perete
pipa medie TM CA8

BMPTM



Baterie apa rece
lebada C15

BMAC15



Baterie multijet
bucatarie crom
SMK5017



Baterie multijet
bucatarie negru
SMK5017-1



Baterie lavoar cu
senzor*
SMK-190



Baterie lavoar cu
senzor*
RW-161



Coloana de dus cu dus
igienic si pipa cada
1752



Baterie lavoar cu
senzor* bronz antichizat
SMK-193



Baterie bucatarie pipa
extractabila
82825-N



Baterie lavoar cu
senzor* crom
RW-199



Baterie lavoar cu
senzor* aurii
RW-199



*Bateriile lavoar cu senzor Smack functioneaza cu 4 baterii alcaline AA (minim 12 luni la 300 actionari pe zi)

Baterie lavoar 6885P
Fara ventil

BSL6885P



Baterie cadă 6881

BS6881



Baterie cadă TL6882S

BSCTL6882S



Baterie cadă
Pipa medie 6882SD

BSCTM



Baterie duș 6883

BSCD



Baterie lebada
bucătărie 6884AP

BSLE6884AP



Baterie bucătărie
Pipa medie 6884DP

BSPM6884DP



Baterie bucătărie
Pipa lunga 6884P

BSB6884P



Baterie lebada 6887P
bucătărie flexibila

BS6887P



Baterie lebada 7811

BS7811



Baterie apa rece 1710

BS1710



Baterie apa rece 6838

BSAR



Baterie bideu 6889

BSBI



Baterie frizer 6910A
(pipa extractibila)

BSF6910A



Baterie cu incalzire
electrica 1901

BSI1901



Baterie de perete
Pipa lunga TL6882

BSPTL



Baterie de perete
Pipa medie TM6882D

BSPTM



Baterie stativa 6836Z

BSS6836Z



Baterie perete 6836

BSPS6836



Robinet pisoar cu
temporizator

RPS



COLECTIA SAONA



A5D187AC00

Pachet dus incastat
SAONA



Baterie lavoar cu ventil

A5A307AC0K



Baterie intalta lavoar cu
ventil

A5A377AC0K



Baterie bideu

A5A607AC0K



Baterie bucătărie

A5A847AC0K



Baterie încastată de duș

A5A2C7AC0K



Baterie duș cu set de duș

A5A2A7AC0K



Baterie cadă/duș cu set de
duș

A5A017AC0K



Baterie duș montată pe
perete

A5A2D7AC0K



Coloana de duș

Inaltime reglabila
855-1230 mm,
brat de duș reglabil, furtun
flexibil,
para duș functie Rain

A5A9709C00



Baterie lavoar

Cu ventil A5A3I09C00
Fara ventil A5A3K09C00



Baterie inalta de lavoar

A5A3C09C00



Baterie bideu

A5A6A09C00



Baterie de duș cu accesorii

A5A2009C02



Baterie cadă/duș cu
accesorii

A5A0109C02



Set baterii
(lavoar, cadă/duș, set duș)

A5DA509C0K



Baterie de bucătărie cu
prindere in perete

A5A7609C00



Baterie stativa pentru
bucătărie

Pipa rotativa
A5A8409C00



Furtun de duș metallic anti-torsionare 1,5 m

A5B2816C00



duș de mana 80 mm
0 functie

A5B9103C00



duș de mana 100 mm
0 functie

A5B9B03C00

Set de duș Stella
Para 100mm
duș cu 3 functii

A5B1D03C00



duș de mana 100 mm
3 functii

A5B1B03C00



Tăviță accesorii de baie
verde inchis ONA

A817670C70



Tăviță accesorii de baie alb
ONA

A817670C60



Tăviță accesorii de baie sand
ONA

A817670C80



Sifon BOTELLA 1 1/4" pentru
lavoar, tub de 250 mm
A506401614



Ventil click clack, crom, Ø 65

A505401000

Coloane de duș



A5D186ENB0

Pachet dus incastrat
CALA NEGRU MAT



A5A9F18NB0

Coloana dus
termostatica Victoria
B NEGRU MAT



A5A9F18C00

Coloana dus
termostatica
Victoria-T



A5B9M61C00





Coloana dus Victoria
Connect New



A5A9A6ENB0

Coloana dus Vega
PLUS NEGRU MAT

Seturi baterii si vase toaleta

				
<p>Set de baterii BAU EDGE:</p> <ul style="list-style-type: none"> • baterie lavoar cu ventil • baterie de dus • furtun, para dus si porter <p>GRO11292601</p>	<p>Set de baterii BAU EDGE</p> <ul style="list-style-type: none"> • baterie lavoar cu ventil • baterie de cada • furtun, para dus si porter <p>GRO11292501</p>	<p>Set de baterii BAU EDGE</p> <ul style="list-style-type: none"> • baterie lavoar cu ventil • baterie de dus • furtun, para dus si bara dus cu porter <p>GRO11292801</p>	<p>Set de baterii BAU EDGE</p> <ul style="list-style-type: none"> • baterie lavoar cu ventil • baterie de cada • furtun, para dus si bara dus cu porter <p>GRO11292501</p>	<p>SET VAS WC BAU CERAMIC</p> <ul style="list-style-type: none"> • Evacuare laterala • Rezervor alimentare laterala • Capac soft-close <p>GRO39347000</p>

Oglinzi cu iluminare led si functii speciale

				
<p>27OG0004</p> <p>ATLANTIS</p> <p>ILUMINARE LED 3 CULORI, 60X60 CM, FUNCTIE DEZABURIRE, INTRERUPATOR TOUCH, CEAS</p>	<p>27OG0007</p> <p>ATLANTIS</p> <p>ILUMINARE LED 3D 60X60 CM</p>	<p>27OG0010</p> <p>CRONOS</p> <p>ILUMINARE LED 3 CULORI, 60X60 CM, FUNCTIE DEZABURIRE, INTRERUPATOR TOUCH, CEAS</p>	<p>27OG0013</p> <p>FORTUNA</p> <p>ILUMINARE LED 3 CULORI, 50X70 CM, RAMA AURIE FUNCTIE DEZABURIRE, INTRERUPATOR TOUCH, CEAS</p>	<p>27OG0006</p> <p>ATLANTIS</p> <p>ILUMINARE LED 3 CULORI, 120X80 CM, FUNCTIE DEZABURIRE, INTRERUPATOR TOUCH, CEAS</p>

Oglinzi cu iluminare led si functii speciale

INFINITY

Iluminare LED 3
culori, 60X80 CM,
Rama aluminiu
neagra, functie
dezaburire, ceas

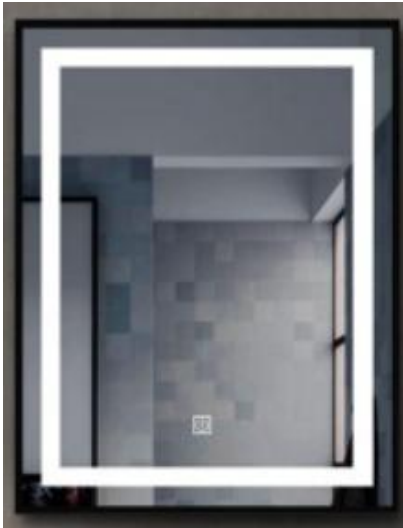

27OG0001

INFINITY

Iluminare LED 3
culori, 120X60 CM,
Rama aluminiu
neagra, functie
dezaburire, ceas



27OG0002

ATLANTIS

Iluminare LED 3
culori, 60X80 CM,
Functie dezaburire,
intrerupator touch,
ceas

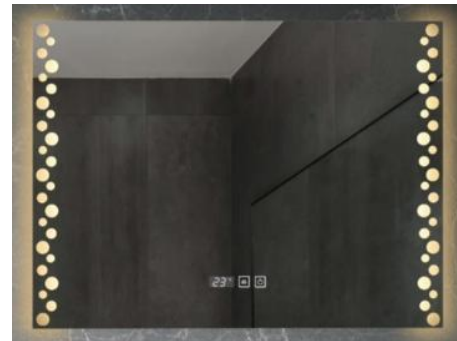

27OG0009

CRONOS

Iluminare LED 3
culori, 120X60 CM,
Functie dezaburire,
intrerupator touch,
ceas



27OG0011

ATLANTIS

Iluminare LED 3
culori, 120X60 CM,
Functie dezaburire,
intrerupator touch,
ceas

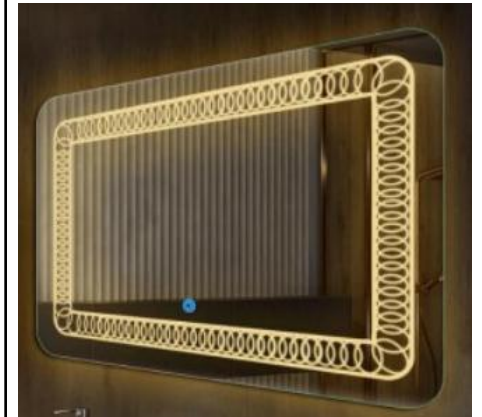

27OG0012

Lavoar din porțelan în blat
DIVERTA



A327116000
550 x 425 x 170 mm

Lavoar din porțelan pe blat
BOL



A327876000
420 x 420 x 230 mm

Lavoar pe blat din porțelan
HORIZON



A32727600B
600 x 420 x 80 mm

Lavoar din porțelan pe blat
OHTAKE



A327A13000
540 x 375 x 185 mm

La comanda:perlat, onix,
bej, cappuccino si maro.

Lavoar din porțelan pe blat
OHTAKE



A327A15000
375 x 375 x 175 mm

La comanda:perlat, onix, bej,
cappuccino si maro.

Lavoar din porțelan pe blat
THE GAP



A3270Y1000
550 x 390 x 130 mm

Lavoar din porțelan pe blat
THE GAP



A3270Y0000
550 x 400 x 130 mm

Lavoar din porțelan pe blat
THE GAP



A3270MN000
600 x 420 x 130 mm

Lavoar din porțelan pe blat
THE GAP



A3270Y2000
600 x 370 x 130 mm

Lavoar suspendat din
porțelan
DEBBA



A325994000
600 x 480 x 150 mm

RIGOLE



Rigola 100H70 + gratar otel zincat stantat trafic 1.5 tone
100x120x92

501000

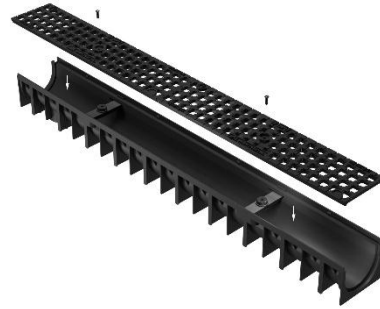

Rigola 100H70 + gratar fonta retea trafic 12.5 tone+Sistem de fixare 100x120x92

501151

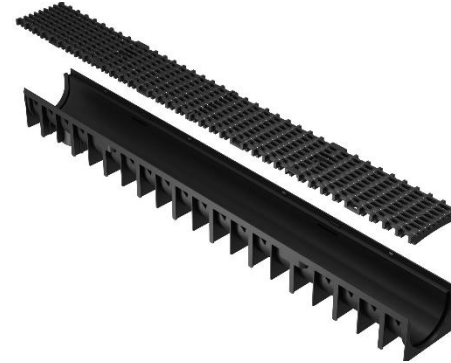

Rigola 100H70 + gratar plastic retea negru trafic 1.5 tone
100x120x92

501300

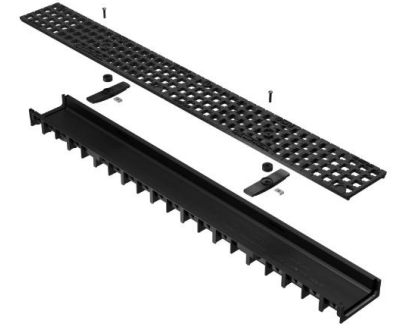

Rigola 100H30 + gratar fonta retea trafic 12.5 tone+Sistem de fixare 100x120x54,5

501201

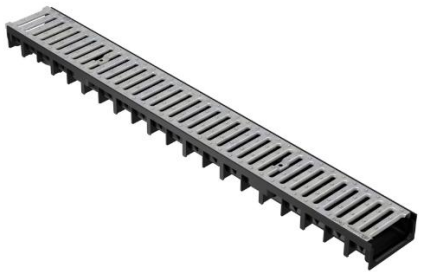

Rigola 100H30 + gratar otel zincat stantat trafic 1.5 tone
100x120x54,5

501100



Rigola drenaj trafic 25 tone, 0.5 metri liniari, diametru 110mm

503000

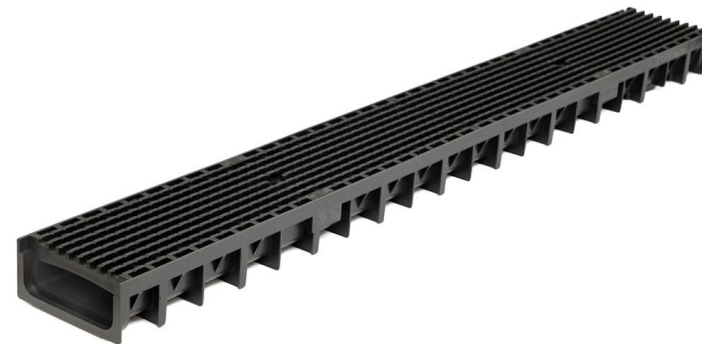

Rigola 100H30 + gratar plastic retea negru trafic 1.5 tone
100x120x54,5

501350

ANCA

DIMENSIUNI(L x L x H):

120 cm x 70 cm x 38 cm
140 cm x 70 cm x 38 cm
150 cm x 70 cm x 38 cm
160 cm x 70 cm x 38 cm
170 cm x 70 cm x 38 cm
170 cm x 75 cm x 38 cm



FANSE

170 cm x 75 cm x 45 cm



CRISTAL

150 cm x 100 cm x 41 cm



NEO

170 cm x 70 cm x 43 cm



CUBIC

170 x 80 x 40 cm



***Toate cazile pot fi echipate cu sisteme de hidromasaj.**

CĂZI DE BAIE DIN ACRIL DREPTE SAU PE COLȚ

***Toate cazile pot fi echipate cu sisteme de hidromasaj.**



GRETA

160 cm x 100 cm x 45 cm
170 cm x 100 cm x 45 cm

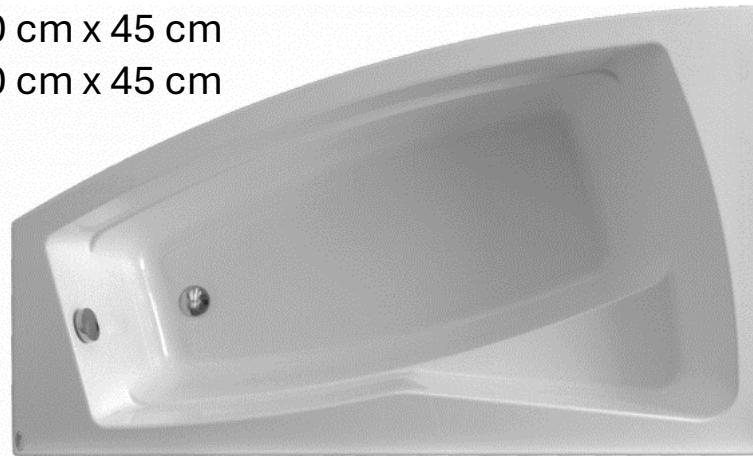
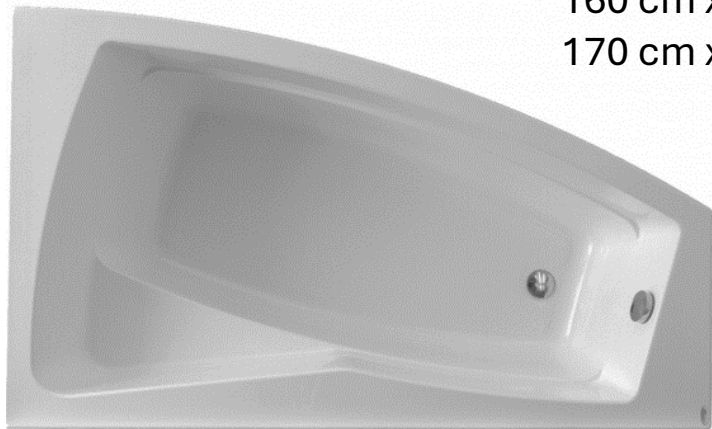

QUADRA

160 cm x 70 cm x 40 cm
170 cm x 70 cm x 40 cm
170 cm x 80 cm x 40 cm
180 cm x 80 cm x 45 cm
180 cm x 100 cm x 45 cm



SIENA

120 cm x 70 cm x 39 cm
150 cm x 70 cm x 39 cm
160 cm x 70 cm x 39 cm
170 cm x 70 cm x 39 cm



ELEGANCE

180 x 80 x 45 cm



CAZI FREESTANDING



KNOSSOS



OSLO



BRISTOL



MALMO (back to wall)



MALMO 150-180/70-80 cm



CAZI FREESTANDING MARMURA/ COMPOZIT

Vayer Volans



Besco Goya



Kuma Luxo



Cast Marble Tivoli

Cast Marble Novara



Besco Goya



Ideal Standard Dea



Ideal Standard Conca

Ideal Standard Around



Vayer Cetus



Cast Marble Cairo



Ideal Standard Tonic II

Cădiță de dus

120 cm x 80 cm x 3,5 cm
90 cm x 90 cm x 3,5 cm
100 cm x 90 cm x 3,5 cm
120 cm x 90 cm x 3,5 cm
140 cm x 90 cm x 3,5 cm
160 cm x 90 cm x 3,5 cm
100 cm x 100 cm x 3,5 cm



Cădiță de dus finisaj texturat

80 cm x 80 cm x 4 cm;
90 cm x 70 cm x 4 cm;
90 cm x 90 cm x 4 cm;
100 cm x 70 cm x 4 cm;
120 cm x 70 cm x 4 cm;
140 cm x 70 cm x 4 cm;
150 cm x 70 cm x 4 cm;
170 cm x 70 cm x 4 cm;
100 cm x 80 cm x 4 cm;
120 cm x 80 cm x 4 cm;
140 cm x 80 cm x 4 cm;
160 cm x 80 cm x 4 cm;
180 cm x 80 cm x 4 cm.



Cădiță de dus dreptunghiulara

90 x 70 cm
110 x 70 cm
120 x 80 cm



Cădiță de dus din porțelan

70 x 70 x 10 cm
80 x 80 x 10 cm
90 x 90 x 10 cm



STICLĂ SIMPLĂ, SABLATĂ SAU CU SERIGRAFIE

*Grosime 6 sau 8 mm
Finisaj crom sau negru*

Paravan de dus WALK-IN

65-67x195cm
75-77x195cm
75-77x195cm
95-97x195cm
105-107x195cm



Usa batanta

65-67x195cm
75-77x195cm
75-77x195cm
95-97x195cm



Închidere de nișă

Gama largă de dimensiuni



Cabină de duș

Gama largă de dimensiuni



Cabine de duș

Cabina dus pentagonala
cu usa batanta Belform
Infinity



Cabina dus dreptunghiulara
cu usa glisanta
Belform Grid



Cabina dus patrata cu usa
batanta Belform Fortuna



Cabina de dus Ura 2L2
ROCA
*diverse dimensiuni



WIRQUIN

Rezervor încastrat cu
clapetă
50x101 cm
50950060



Izolatie inclusa, cadru din
otel vopsit anicoroziune,
mecanism standard,
robinet flotor 3/8, robinet
de trecere 1/4 tura si placa
de comanda alba cu dubla
apasare.
Inaltime ajustabila la
instalare.

WIRQUIN

Rezervor încastrat
36x98.2 cm
50950176



Izolatie inclusa prin perete
dublu, cadru din otel
vopsit anicoroziune,
mecanism standard,
robinet flotor 3/8, robinet
drept 1/4 tura si placa de
comanda crom lucios cu
dubla apasare.
Inaltime ajustabila la
instalare.

WIRQUIN

Pachet rezervor încastrat
cu vas WC si capac
36x98.2 cm
55950003



Izolatie inclusa prin perete
dublu, cadru din otel vopsit
anicoroziune, mecanism
standard, robinet flotor 3/8,
robinet drept 1/4 tura si placa de
comanda alb lucios cu dubla
apasare.
Inaltime ajustabila la instalare.

LIV

Rezervor încastrat cu
clapetă de acționare
albă
55x110 cm
F-9012



Complet izolat împotriva
condensării.
Suporturi de perete
asamblate și picioare
reglabile (0-200 mm).
Doua posibilitati de
conectare la alimentarea cu
apa.
Rezervor incastrat echipat
cu robinet oprire preinstalat
- dreapta sus

Rezervor încastrat
complet preasamblat
50 x 112 cm **TECE**
9400412

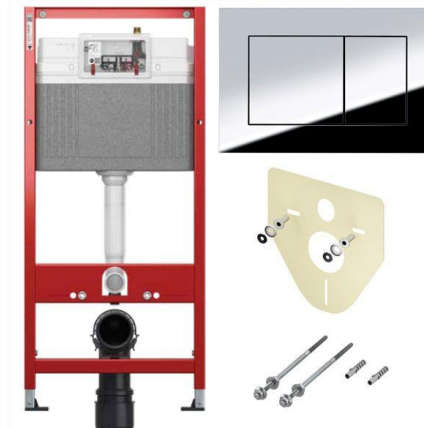

Racord de rezervor cu filet
exterior de R 1/2" in partea
superioara.
Robinet de inchidere cu 3 cai cu
functie de spalare, cu supapa de
umplere preinstalata
Volumul rezervorului 10 litri;
volum de spalare standard
presetat de 6 litri, poate fi setat
opțional in orice moment un
volum de spalare de 4,5/7,5/9
litri; volum partial de spalare de
3 litri cu sistem cu acționare
dubla; volumul ramas poate fi
folosit pentru o spalare
ulterioara.
Izolot impotriva condensului.

Sistem instalare pentru
vas wc DUOFIX UP 182
CAL. I

GEB458.160.00.1



Set RAPID SL 3 IN 1 cu
clapeta SKATE COSMO
si suruburi CAL. I

GRO38772001



Sistem instalare WC
PROSYS 120 MM
IDEAL STANDARD

IDSR0306AA



Set rezervor incastat Geberit Duofix
UP100 cu cadru, garnitura
fonoizolanta, sistem de fixare si
clapeta Delta 51 alba

GEB458.128.11.1

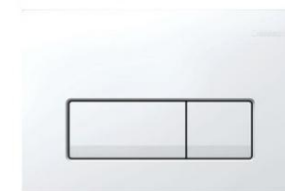

Active - sistem de instalare
pentru vas WC suspendat,
rezervor cu mecanism cu
dublă acționare 6/3 L și 4,5/3 L

A89011001B



Set rezervor incastrat usor de fixat si siletios



Ideal Standard

Rezervor incastrat cu
clapeta Oleas M2 alb



E2332AC

Rezervor incastrat cu
clapeta Oleas M2 crom



E2332AA

Rezervor incastrat cu
clapeta Oleas M1 crom



R0466AA

Rezervor incastrat cu
clapeta Oleas M1 alb



R0466AC

Sanitare colectia TESI



Ideal Standard

Vas WC suspendat AquaBlade 37x54 cm evacuare orizontala, fixare complet ascunsa

T007901



Bideu suspendat

T457001



Vas WC pe pardoseala AquaBlade 36x66 cm evacuare orizontala sau verticala, rezervor cu alimentare inferioara si capac slim soft-close

T356801



Vas wc pe pardoseala AquaBlade pentru rezervor ingropat

T007701



Bideu cu montaj pe pardoseala cu spatele lipit de perete

T456901



T352701

T008701

Lavoar si semi-piedestal din porțelan
A325196000 si A335191000

DIMENSIUNI:
500 x 400 x 200 mm
Set de fixare: Inclus



10 ani Garantie

Vas de toaleta patrat suspendat
Rimless Debba
A34699L000



PACHET INSPIRA SQUARE ONYX
RIMLESS
A893105860



PACHET INSPIRA ROUND ONYX RIMLESS

A893104871



VAS DE TOALETA PATRAT
SUSPENDAT RIMLESS
DEBBA

A34699L000



WC SUSPENDAT ROTUND
RIMLESS DEBBA

A346998000



VAS WC SUSPENDAT
RIMLESS CU PRINDERI
ASCUNSE THE GAP

A34647L000



Pack Meridian Compact
Rimless (wc+capac)

A34H242000



PACHET WC ADELE PE
PARDOSEALA, REZERVOR SI
CAPAC
A34P195000



PACHET ONA RIMLESS

A893106900



PACHET MERIDIAN
COMPACT RIMLESS

A893104790



PACHET GAP ROUND
RIMLESS, PRINDERE
ASCUNSA
A893104840



PACHET GAP ROUND
RIMLESS, PRINDERE
APARENTA
A893104830



PACHET DEBBA SQUARE

A893104750





Kit conectare WC
180 mm, DN 90, PP

VS58933C000000



Kit Conectare WC
300 mm, DN 90

VS58932C000000

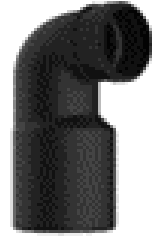

Cot Conectare WC
90 Grade, DN
90/DN100

VS58901C000000



Cot Conectare WC
90 Grade, DN
90/DN100, 3 trepte

VS58906C000000



Teava conectare
WC 400 mm

VS58997C000000



Set Fonoabsorbant
pentru Wc si Bideu

VS16002C000000



Sifon lavoar Design
607 G1 1/4x32
Negru mat

VS31020C560000



Sifon lavoar Design
607 G1 1/4x32
Crom

VS31017C000000



Sistem evacuare
cadă flexibil cu
preaplin crom,
cablu 650mm,
evacuare diametru
40/50 mm

VS35333C00S000



Sistem evacuare
cadă flexibil cu
preaplin negru
mat, cablu
650mm, evacuare
diametru 40/50
mm

VS35333C56S000

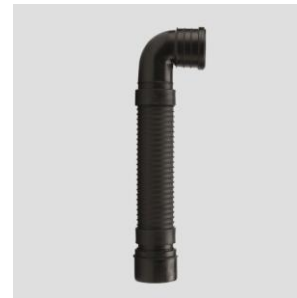

Conector WC
flexibil 3 trepte
DN90/DN100

VS58939C000000



Set racord WC
DN90 cu blocator
de șobolani

VS58935C000099



Cot de conectare
la WC 90 de grade
cu blocator
sobolani, alb

VS58114C010000

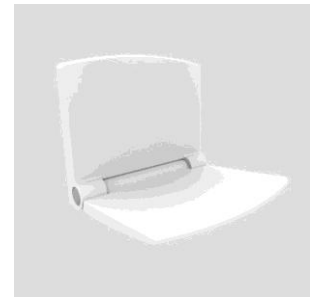

Scaun duș alb

VS54002C010000

FITINGURI SPECIALE PP

Mufă adaptor
40/40



CRP4400

Mufă adaptor
50/50



CRP5500

Mufă reducere
110/40



CRPA400

Mufă reducere
110/50



CRPA500

Mufă reducere
110/50



CRPAA00

Dop D32 cu
conector rotativ,
furtun 10-13 mm



UZ30RU0PZ

Dop D32 cu
conector rotativ,
furtun 19-21 mm



UZ30RU0PZ

Dop D40 cu
conector rotativ,
furtun 10-13 mm



UZ40RU0PZ

Dop D40 cu
conector rotativ,
furtun 19-21mm



UZ40R00PZ

Dop D50 cu
conector rotativ,
furtun 10-13 mm



UZ50RU0PZ

Dop D50 cu
conector rotativ,
furtun 19-21mm



UZ50R00PZ

Dop D32 cu
conector drept,
furtun 8-25 mm



UZ30000PZ

Dop D40 cu
conector drept,
furtun 8-25 mm



UZ40000PZ

Dop D50 cu
conector drept,
furtun 8-25 mm



UZ50000PZ

Intretinere si utilizare:

1. Montajul rezervorului wc se va face conform instructiunilor de montaj. Va rugam sa cititi cu atentie si sa respectati aceste indrumari, pentru a evita montarea si utilizarea defectuoasa a produsului.
2. Rezervorul wc se va curata folosind o carpa moale, inmuata in apa sau in detergent bland, non-abraziv, non-coroziv si fara continut de clor, dupa care se va sterge cu o carpa uscata. Este interzisa folosirea dezinfectantilor si a produselor de curatare care contin solventi chimici, clor sau alcool.
3. Pe suprafata rezervorului wc este interzisa asezarea de obiecte grele, fierbinti, lipicioase, murdare sau care pot duce la deteriorarea produsului.
4. Pentru o utilizare optima, rezervorul wc trebuie alimentat cu apa ce corespunde standardelor privind calitatea apei potabile



BETA

Forme simple și armonioase, funcționare intuitivă pornire-oprire și întreținere ușoară. (8l)

1030



CONCEPT 2

Funcționare, echipare și design de ultimă oră: alegerea tehnică perfectă, conform stilului băii. (8l)

1000C2FX



EXPORT

La îndemână și de încredere, cu forme simple, pătrate, ultraplăt. (8l)

1034R



TOP

Rezervor ultraplăt, eco-sustenabil: economisește apa și este earth-friendly. Intelligent, simplu si la îndemână. (6l)

1075



**ȚEAVĂ SEMIÎNĂLȚIME
Ø50x44,
LUNGĂ 642x330 mm**

Potrivită pentru rezervoare wc cu montaj la semiînălțime

1501BLACC

ȚEAVĂ SEMIÎNĂLȚIME

**Ø50x32,
800x260 mm**

Potrivită pentru rezervoare wc cu montaj la semiînălțime

1508



ȚEAVĂ SEMIÎNĂLȚIME Ø50x44

330x210 mm, cu garnituri
Potrivită pentru rezervoare wc cu montaj la semiînălțime

1501AACC

REZERVOR

Pentru instalare pe perete;
Montaj la semiînălțime;
Buton cu acționare dublă, cu posibilitatea reglării volumului de apă;
Rezistență la îngălbenire;
Capacitate de 6/8 litri cu reglaj;
Izolare anticondens și fonic;
Racordarea la sursa de apă: stânga, dreapta sau central posterior;
Robinet flotor 3/8" compact, cu umplere rapidă și silențioasă;
Cu țeavă scurgere apă.



Racord WC FLEXIBIL-EXTENSIBIL
L 250-530 MM

1221



Racord WC FLEXIBIL-EXTENSIBIL
Cu inserție metalică
L 220-540 MM

1224



Racord WC CU COT LA 90° ȘI
RACORD MS, L 229 MM
leșire Ø110

KK95000N



Racord WC CONCENTRIC
leșire Ø100-110

1641



Racord WC EXCENTRIC
Ø100-110
leșire Ø100-110

1641E



Racord WC DREPT, L 250 MM
leșire Ø110

KP25000



Racord extensibil-flexibil
Cu piuliță din plastic 1 1/4
leșire Ø 32-40

8056



Racord extensibil-flexibil
Cu piuliță metalică 1 1/4
leșire Ø 32-40

8056/O



Racord flexibil-extensibil
Cu piuliță din plastic 1 1/4
leșire Ø32-40
Ventil cu grătar din inox 1 1/4
Dop cu mâner

8056/V



Racord flexibil-extensibil
Cu piuliță din plastic 1 1/4
leșire Ø 40-50
Ventil cu grătar din inox 1 1/4
Dop cu mâner

8056/V50



Racord extensibil-flexibil

Cu piuliță din plastic 1"1/2
leșire Ø 40-50

8058



Racord flexibil-extensibil

Cu piuliță din plastic 1"1/2
Racord pentru mașina de spălat
Reducție de la 1"1/2 la 1"1/4

8058/MSR



Racord extensibil-flexibil

Cu piuliță metalică 1"1/2
leșire Ø 40-50

8058/O



Racord flexibil-extensibil

Cu piuliță din plastic 1"1/2
leșire Ø32-40
Ventil cu grătar din inox 1"1/2
Dop cu mâner

8058/V40



Racord flexibil-extensibil

Cu piuliță din plastic 1"1/2
leșire Ø 40-50
Ventil cu grătar din inox 1"1/2
Dop cu mâner

8058/V50



Racord extensibil-flexibil

Cu piuliță din plastic 1"1/2
leșire Ø 32-40

8059



Racord flexibil-extensibil

Cu piuliță din plastic 1"1/2
Curbă la 90°
leșire Ø40-50

8059/S



Racord extensibil-flexibil

Cu piuliță metalică 1"1/2
leșire Ø 32-40

8059/O



Ventil pop-up 3"1/2x1"1/2
Pentru chiuvete inox și compozit
Cu preaplin universal
(dreptunghiular + rotund 3R) în
cuva
Dop grătar din inox

S475UNIV



Ventil 2"1/2x1"1/2

Pentru chiuvete inox
Cu preaplin dreptunghiular în
cuva
Dop cu mâner

3230F

Sifon cada automat cu preaplin cromat pentru cadă

Lungime 550-650 mm
Ieșire Ø40-50
Dop Ø70

5012FPL



Sifon cada cu preaplin, lanț și dop pentru cadă

Lungime 550-650 mm
Ieșire Ø40-50

5012PL



Sifon pentru cadă cu preaplin Ventil click-clack

Lungime 550-620 mm
Ieșire Ø40-50

5012CL



Scurgere pentru cădiță duș

Grătar plat din inox
Cu ventil Ø80
Intrare 1"1/2
ieșire Ø40-50

5020



Sifon pentru cădiță duș

Grătar plat din inox
Cu ventil Ø80
Intrare 1"1/2
ieșire Ø40-50

5016



Sifon "U" 1"1/2 - Pentru chiuvete
inox
Cu ventil 2"1/2x1"1/2 cu preaplin
dreptunghiular în cuvă
Cu racord pentru mașina de
spălat
Ieșire Ø40
5222TP



Ventil 3"1/2x1"1/2
Pentru chiuvete inox
Cu preaplin dreptunghiular în
cuvă
Dop grătar inox
3235F



Ventil 3"1/2x1"1/2
Pentru chiuvete inox
Cu preaplin dreptunghiular în
cuvă
Dop grătar click-clack din inox
S470/L



Sifon pentru cădiță duș
Pentru cădițe de duș cu orificiu
Ø60
Cu capac din inox cromat Ø90
Ieșire Ø40

5085



Ventil pentru lavoare
Dop cu maner
1"1/2: 3328
1"1/4: 3326



MECANISM PENTRU
REZERVOR
BETA/ANGOLO

Complet accesoriizat,
Instalare rapidă.

1400B



ȚEAVĂ FLEXIBILĂ
SEMIÎNĂLȚIME

Țeavă flexibilă Ø50, 900 mm, cu
garnituri
Potrivită pentru rezervoare wc cu
montaj la semiînălțime

1501FLEX



MANȘON
interior Ø40,
exterior Ø55-60

Potrivit pentru a asigura
etanșarea
perfectă între țeavă și vasul de
toaletă

Set 10 bucăți
1524A-10



BLUE RAMBO

ALIMENTARE
LATERALĂ
3/8"

Robinet
flotor simplu și eficient. De
înalță performanță și compatibil
cu orice tip de rezervor wc.

1520AMB



ROBINET FLOTOR BLACK
RAMBO
3/8"

Flotorul Black Rambo este
extrem de
 silențios și eficient, asigurând o
etanșare excelentă la închidere
chiar
și la presiune hidraulică ridicată.

1512AMB



ROBINET FLOTOR BLACK
RAMBO
1/2"

1512AMB1/2



SET MECANISM PNEU BUTON
UNIC ȘI
FLOTOR LATERAL

Potrivit pentru rezervoare wc
monobloc din ceramic

1402A



SET MECANISM APĂSARE BUTON
UNIC ȘI FLOTOR LATERAL
Potrivit pentru rezervoare wc
monobloc din ceramic

1402



SET MECANISM TRAGERE
BUTON
UNIC ȘI FLOTOR LATERAL
Potrivit pentru rezervoare wc
monobloc din ceramic

1402T

Intretinere si utilizare:

1. Montajul mecanismului wc se va face conform instructiunilor de montaj. Va rugam sa cititi cu atentie si sa respectati aceste indrumari, pentru a evita montarea si utilizarea defectuoasa a produsului.
2. Pentru o utilizare optima, rezervorul wc trebuie alimentat cu apa ce corespunde standardelor privind calitatea apei potabile.



SIFON PENTRU
PARDOSEALĂ

100x100 MM,
IEȘIRE VERTICALĂ Ø40

1700



SIFON PENTRU
PARDOSEALĂ

150x150 MM,
IEȘIRE VERTICALĂ Ø50

1701



SIFON PENTRU PARDOSEALĂ

250x250 MM,
IEȘIRE VERTICALĂ Ø110

1703



SIFON PARDOSEALĂ

96x96 MM,
IEȘIRE LATERALĂ Ø32
Grătar din inox

1707L



SIFON PARDOSEALĂ

96x96 MM,
IEȘIRE VERTICALĂ Ø32
Grătar din inox

1707V



SIFON PARDOSEALĂ

96x96 MM
IEȘIRE LATERALĂ Ø40
Grătar din inox

1708L



SIFON PARDOSEALĂ

96x96 MM
IEȘIRE VERTICALĂ Ø40
Grătar din inox

1708V



SIFON GRAVITAȚIONAL CU
ÎNĂLȚĂTOR PENTRU
PARDOSEALĂ
100x100 MM IEȘIRE
LATERALĂ Ø50
Grătar din inox

Sifonul împiedică eficient
răspândirea mirosurilor
provenite de la canalizare
V-1340.64



SIFON GRAVITAȚIONAL CU
ÎNĂLȚĂTOR PENTRU
PARDOSEALĂ
100x100 MM
IEȘIRE VERTICALĂ Ø50
Grătar din inox

Sifonul împiedică eficient
răspândirea mirosurilor
provenite de la canalizare
V-1340.64



SIFON PARDOSEALĂ CU
ÎNĂLȚĂTOR
100x100 MM ÎN LINIE Ø50
IEȘIRE VERTICALĂ Ø50
Grătar din inox

Sifonul împiedică eficient
răspândirea mirosurilor
provenite de la canalizare
V-1340.66



CRETA
Închidere lentă
Balamale metalice detașabile
(take off)
pentru o curățare ușoară

1108E



LEGERINO INOX
Material: duroplast
(antibacterian)
Închidere standard
Balamale din inox cu fixare
rapidă

1110



LEGERINO INOX
Material: duroplast
(antibacterian)
Închidere lentă
Balamale din inox cu fixare
rapidă

1110SC

ATLANTIC



Capac universal. Polipropilenă
Închidere standard
Balama uniblock din
polipropilenă cu 4 ajustări,
șuruburi și piulițe din rășină
acetalică

1100

ATLANTIC



Blue Chiaro

ATLANTIC



Bermuda blue

ATLANTIC



Electric blue

ATLANTIC



Calypso green

ATLANTIC



Bahama bej

ATLANTIC



Rosu

Mobilier cu lavoar incorporat

			
<p>ELEGANT PLUS, 60/80</p> <p>Mobilier de baie mască lavoar cu două sertare și lavoar</p> <p>60cm: A852018806 80cm: A852019806</p> <p>*Manerele se comanda separat</p>	<p>VICTORIA BASIC</p> <p>Unitate de bază MDF cu două uși și lavoar portelan</p> <p>60cm: A855854806 80 cm: A855852806</p> 	<p>ROMA COMPACT</p> <p>Mobilier de baie compact mască lavoar cu două sertare și lavoar</p> <p>60cm: A852473806</p>	<p>ALPINE</p> <p>Unitate de bază MDF cu două uși și lavoar portelan</p> <p>60cm: A852012464 70cm: A852013464 80 cm: A852014464</p> 

 	 	 	 
<p>Mobilier 60 cm cu lavoar, doua sertare</p> <p>SELNOVA SQUARE</p> <p>GEC501.237.00.1 GEC501.238.00.1 GEC501.239.00.1 GEC501.236.00.1</p>	<p>Mobilier 80 cm cu lavoar, doua sertare</p> <p>SELNOVA SQUARE</p> <p>GEC501.240.00.1 GEC501.241.00.1 GEC501.242.00.1 GEC501.243.00.1</p>	<p>Set lavoar cu margine ingusta si mobilier cu 2 usi 80 cm</p> <p>SELNOVA SQUARE</p> <p>GEC501.259.00.1 GEC501.258.00.1 GEC501.256.00.1 GEC501.257.00.1</p>	<p>Set lavoar cu margine ingusta si mobilier cu o usa 60cm</p> <p>SELNOVA SQUARE</p> <p>GEC501.254.00.1 GEC501.252.00.1 GEC501.253.00.1 GEC501.255.00.1</p>

**ROMAX 4000 - Mașină de presat electro-hidraulică
cu acumulator 18V, 4.0 Ah**

1000001840

Setul conține: Mașină de presat ROMAX 4000, acumulator 18 V / 4.0 Ah (cod 1000001653), încărcător (cod 1000001654), geantă transport ROCASE tip 6414.



**ROMAX AC ECO - Mașină de presat electro-hidraulică,
230V 15705**

Setul conține: Mașină de presat ROMAX AC ECO, geantă transport ROCASE tip 6414



Capete de presare

Standard



Compact



**SUPERTRONIC 2000 Pentru filetare electrică portabilă
până la 2" 71256**

Setul conține: SUPERTRONIC 2000 cu contrasupport (art.nr. 71280), adaptor ROFIX (art.nr. 71271), capete de filetat de precizie 1/2-3/4-1-1.1/4-1.1/2-2", totul în cutie ROCASE 6414 (art.nr. 1000001953)



SUPERTRONIC 2000 E - Pentru filetare electrică portabilă cu wacumulator 18V/4Ah și încărcător 1000003389

Setul conține: SUPERTRONIC 2000 E
cu contra-suport (art.nr. 71280), adaptor
ROFIX (art.nr. 71271),
capete de filetat de precizie
1/2-3/4-1-1.1/4-1.1/2-2", acumulator
18V/4Ah, încărcător acumulator,
totul în cutie ROCASE 6414 (art.nr.
1000001953)



SUPERTRONIC 1250 Pentru filetare electrică portabilă până la 1 ¼" 71450

Setul conține: clupă electrică de
filetat Supertronic 1250 (art.nr.
71350), contra-suport (art.nr.
71279), capete de filetat de
precizie 1/2-3/4-1-1.1/4", în cutie
din plastic



SUPERTRONIC 2 SE Mașină staționară / mobilă pentru filetarea țevilor și niplelor max. 2 țoli 1500004023

Setul conține: SUPERTRONIC 2SE,
cap de filetat
automatic 1/2-2", Set bacuri de
filetare 1/2-3/4,
1-2", comutator de picior
de siguranță,
4 picioare de sprijin



SUPERTRONIC 3SE Mașină staționară / mobilă pentru filetarea țevilor și niplelor până la 4" 56255

Setul conține: SUPERTRONIC 3SE capete de filetat automate
până la 3", set bacuri de filetat de la 1/2" la 3" .



SUPERTRONIC 4SE Mașină staționară / mobilă pentru filetarea țevelor și niplelor până la 4" 56465



Setul conține: SUPERTRONIC 4SE, capete de filetat automate până la 4", set bacuri de filetat de la 1/2" la 4"

Clește pentru randalinat filete - Necesari pentru îmbinări de calitate 56500



ROGROOVER 1" - 12"

Dispozitiv electro-hidraulic pentru canelarea țevelor de oțel cu diametre între Ø 1"-12" 1500001351

Setul conține: Mașină ROGROOVER 1-12", Stativul suport țevi, Axele de antrenare 1" - 1.1/2"; 2" - 6"; 8" - 12", Ruletă de măsurat canale (art. nr. 150000134), Chei ajutătoare



ROGRIP F - Clește tip "papagal" cu reglare rapidă automată



Prindere perfect
sigură în 3 puncte
a țevii de 2"



Forma curbilor:
design ergonomic
Rothenberger

ROGRIP F 1K 1.1/4" - 100002701
ROGRIP F 2K 1.1/4" - 100002702
ROGRIP F 1K 2" - 100002704
ROGRIP F 2K 2" - 100002705

Clește tip "papagal" model SP



1" 70527
1.1/4" 70528
1.1/2" 70529



Dinți întăriți prin inducție/ Suprafață de prindere asimetrică/ Dimensiuni favorabile pentru colțuri/ Protecție la zdrobire și la ciupire/ Clești cu autofixare/ Mâner anti-alunecare cu formă ergonomică



Clește tip "suedez" SUPER S 45°

Prindere cu autofixare în 3 puncte, siguranță și stabilitate chiar și la țevi netede.
Dinți căliți prin inducție, înclinați împotriva sensului de rotație
Mâner solid, profilat ergonomic, cu secțiune dublu T pentru rezistență sporită și priză bună
Oțel crom-vanadiu, forjat în matriță, călit, cu mâner ranforsat, fălci lustruite și dimensiuni favorabile pentru colțuri



1" 070121X
1.1/2" 070123X

SCULE

<p>Cutter INTERLOCK metal DE 18mm blister</p> <p>0-10-018</p> <p>STANLEY</p> 	<p>Cutter cu lama lunga 18MM blister</p> <p>0-10-151</p> 	<p>Set 10 lame</p> <p>9MM 0-11-300 18 MM 0-11-301</p> 	<p>Set 5 lame cu cioc tip 1996</p> <p>0-11-983</p> 	<p>Cutter plastic ABS DE 18mm</p> <p>1-10-151</p> 	<p>Lama rotunda razuator surform</p> <p>5-21-299</p> <p>STANLEY</p> 
<p>Ruleta 8M blister</p> <p>0-30-457</p> <p>STANLEY</p> 	<p>Ruleta 3M</p> <p>0-30-487</p> <p>STANLEY</p> 	<p>Ruleta 5M</p> <p>0-30-497</p> <p>STANLEY</p> 	<p>Ruleta TYLON 5M</p> <p>0-30-696</p> 	<p>Ruleta carcasa inchisa banda fibra de sticla</p> <p>20M 0-34-296 30M 0-34-297</p> 	<p>Ruleta galbena 8M</p> <p>1-30-457</p> 

SCULE

Ruleta galbena 3M

1-30-487



Ruleta galbena 5M

1-30-497



Ruleta TYLON 8M

1-30-656



Ruleta TYLON 3M

1-30-687



Ruleta TYLON 5M

1-30-697



Surubelnita 80X150MM

0-64-921

STANLEY



Surubelnita lata
5X150MM

1-60-006



Set 6 surubelnite

FMHT0-62626



Set surubelnita cu 33
varfuri cu magnet

STHT0-70885



Adaptor magnetic
pentru varf surubelnita
60 mm, 1/4" - 5 buc

1-68-732



Set 7 bucati varfuri
surubelnita 60 mm, 1/4"







1-68-735



Set 25 buc varfuri
25mm
Antrenare hexagonala



SCULE

<p>Nivela 40CM – STHT1-43102 60CM – STHT1-43103 80CM – STHT1-43104 100CM – STHT1-43105 120CM – STHT1-43106 150CM – STHT1-43107</p> 	<p>Nivela cu magnet 40CM – STHT1-43110 60CM – STHT1-43111 80CM – STHT1-43112 120CM – STHT1-43114 150CM – STHT1-43115</p> <p>STANLEY</p> 	<p>Foarfece tabla taietura pe stanga</p> <p>2-14-562</p> 	<p>Foarfece tabla taietura dreapta</p> <p>2-14-563</p> 	<p>Foarfece tabla taietura pe partea dreapta</p> <p>2-14-564</p> 	<p>Foarfece tabla lama lunga 90MM</p> <p>2-14-566</p> 
<p>Capsator AL negru capse TIP A</p> <p>4-14MM - 6-TR150L 4-10MM - 6-TR45</p> 	<p>Pachet 1000 capse tapiterie TipA 4MM</p> <p>1-TRA202T</p> 	<p>Pachet 5000 capse tapiterie TipA 6MM</p> <p>1-TRA204-5T</p> 	<p>Pachet 1000 capse tapiterie TipA 6MM - 1-TRA204T 8MM - 1-TRA205T 10MM - 1-TRA206T</p> 	<p>Pachet 1000 capse tapiterie TipA 12MM – 1-TRA208T 14MM – 1-TRA209T</p> 	<p>Set 2 bucat marker permanent (subtire+normal)</p> <p>0-47-312</p> 

SCULE

Creion rosu tamplarie
mina HB 176mm

1-03-850



Creion verde zidarie
mina 4H 176mm

1-03-851



Cleste tras nituri MR55

0-69-804



Cleste papagal 240MM
ajustare in 7 trepte

2-84-301



Cleste universal
(patent) 180mm

STHT0-74454



Fierastrau arcuit
pentru gradinarit

530MM - 1-15-379
760MM - 1-15-403



Fierastrau tamplar
500MM

2-15-599



Sfoara pentru trasat
30M

0-47-440



Praf de cretă 115g

Albastru - 1-47-403
Roșu - 1-47-404



Ciocan dulgher 600GR
cu magnet, varf
despicat

1-51-037

STANLEY



Creion de tensiune
110-250V 30X105MM

STHT0-66121

STANLEY



Organizator neajustabil
(34x26x5,7CM)

1-92-761



Electrozi și aparate de sudură



Aparat de sudură

Bestar 155-ND

B18256-1



Aparat de sudură

Bestar 170-ND

B18257-1

Electrozi
SUPERTIT FIN



W000288260
W000288261

2.5X350
3.2X350

Electrozi
SPEEDARC



W000287024
W000263637

2.5X350
3.2X350



Electrozi SUPERBAZIC

W000288306
W00288307

2.5X350
3.2X350

Electrozi ARCWELD



C08P005R6E02
C08P015P6E02
C10P005R6E02
C10P015P6E02

0.8X0.5X200
0.8X0.5X300
1x0.5x200
1x0.5x300

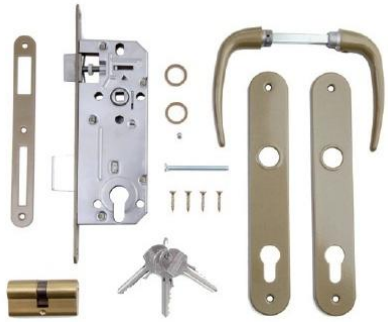

PACHET BROASCA BUTUC Y90 ALB
ALB: 35-501YALB
ARGINTIU: 35-501ARG
MARO: 35-501YMARO
AURIU: 35-501ORO

Broască îngropată pentru uși din profile de aluminiu sau oțel. Acționată cu cilindru profil european cu camă DIN. Zăvorul are 1 cursă de 16 mm. Limbă reversibilă. Pătrat de 8 mm. Interax 90 mm. Intrare 20 mm.



35-35



PACHET BROASCA CHEIE P90
ALB: 35-500PALB
ARGINTIU: 35-500ARG
MARO: 35-500MARO
AURIU: 35-500ORO



Pachetul broasca cu butuc (poza orientativa pentru set)
Material: Metal
Culoare: Negru

35-512NY90

Broască îngropată cu CUTIA DESCHISĂ, acționată cu cheie. Limbă reversibilă. Pătrat de 8 mm. Interax 72 mm. Intrare 42,5 mm. Grosime placă frontală 2 mm.



35-53P72NAT

Broască îngropată cu CUTIA ÎNCHISĂ, acționată cu cheie. Zăvorul are 2 curse de 9 mm. Limbă reversibilă. Pătrat de 8 mm. Interax 90 mm. Intrare 42,5 mm. Grosime placă frontală 2,5 mm.



Disponibil ca finisaje zincat alb si zincat natur

35-33PZI/35-33PNAT

Broască îngropată cu CUTIA ÎNCHISĂ, acționată cu cheie. Zăvorul are 2 curse de 10,5 mm. Limbă reversibilă. Pătrat de 8 mm. Interax 90 mm. Intrare 40 mm. Grosime placă frontală 2,5 mm.



Disponibil ca finisaje zincat alb si zincat natur.

35-174PZI/ 35-174PNAT

Broască îngropată cu CUTIA ÎNCHISĂ, acționată cu cilindru profil european cu camă DIN. Zăvorul are 2 curse de 9 mm. Limbă reversibilă. Pătrat de 8 mm. Interax 90 mm. Intrare 42,5 mm. Grosime placă frontală 2,5 mm.



Disponibil ca finisaje: ZINCAT GALBEN / NATUR

35-34YZI/ 35-34YNAT



BROASCĂ APLICATĂ CHEIE DREAPTA

Interax 65 mm. Intrare 50 mm. Pătrat 8 mm.











12-08

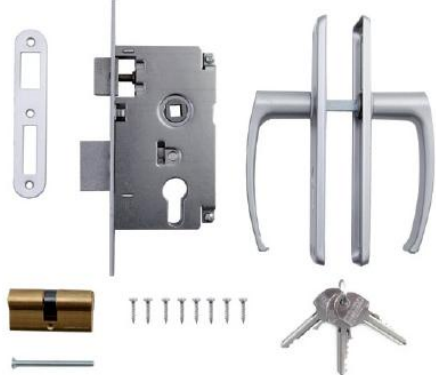

BROASCĂ APLICATĂ CHEIE STÂNGA

Interax 65 mm. Intrare 50 mm. Pătrat 8 mm.

12-09

<p>Broască îngropată cu CUTIA ÎNCHISĂ, acționată cu cilindru profil european camă DIN. Zăvorul are 2 curse de 10,5 mm. Limbă reversibilă. Pătrat de 8 mm. Interax 90 mm. Ințrare 40 mm. Grosime placă frontală 2,5 mm</p>  <p>ZINCAT: 35-175 YZI ZINCAT ALB: 35-175YZA</p>	<p>MANER CU SILD ARAD CHEIE 701-159MARO</p> <p>Disponibil si: Argintiu: 701-159ARG Auriu: 701-159ORO</p> 	<p>Broască îngropată cu CUTIA ÎNCHISĂ, acționată cu cheie. Limbă reversibilă. Pătrat de 8 mm. Interax 55 mm. Ințrare 55 mm. Grosime placă frontală 2 mm.</p>  <p>35-102PZA</p>	<p>Garnitură mâner cu șild. Tijă pătrată 8x8 mm. Interax 72 mm.</p> <p>701-63MARO</p> 	<p>Garnitură mâner cu șild. Tijă pătrată 8x8 mm. Interax 72 mm.</p> <p>CULOARE: MARO 701-97MARO</p> 
<p>Pachet BROASCA + MANER Culoare: auriu</p> <p>35-503ORO</p> 	<p>Pachet Broasca Butuc Culoare argintiu</p> <p>35-502ARG</p> 	<p>CIL CU CHEI CENTRAT</p> <p>25/25: C60C 30/30: C70C 35/35: C80C 40/40: C90C</p> 	<p>CIL CU CHEI DESCENTRAT</p> <p>20/30: C60D 25/35: C70D</p> 	<p>Broască îngropată cu CUTIA ÎNCHISĂ, acționată cu cheie. Zăvorul are 2 curse de 10 mm. Limbă reversibilă. Pătrat de 8 mm. Interax 90 mm. Ințrare 40 mm. Grosime placă frontală 2,5 mm</p> <p>35-32PNI</p> 

BROASTE SI BALAMALE



Broască aplicată, acționată cu cilindru cu cheie verticală. Zăvorul are 2 curse de 11 mm. Montare universală stânga sau dreapta. Intrare 58,5 mm

41-11

Disponibil ca finisaje: placă frontală VOPSIT AAL1 / MARO / ALB / NEGRU



Broască îngropată cu ROLĂ

35-13

Broască îngropată cu CUTIA ÎNCHISĂ, acționată cu cheie.

Zăvorul are 1 cursă de 10 mm.

Limbă reversibilă. Pătrat de 8 mm.

Interax 72 mm.

Intrare 55 mm.



35-243P55

Broască îngropată cu CUTIA ÎNCHISĂ, acționată cu cheie. Zăvorul are 1 cursă de 10 mm.

Limbă nereversibilă, sens funcționare STÂNGA.

Pătrat de 8 mm. Interax 72 mm. Intrare 55 mm. Grosime placă frontală 3 mm.



35-235P55/72

Broască îngropată cu CUTIA ÎNCHISĂ, acționată cu cheie. Zăvorul are 2 curse de 9 mm. Limbă reversibilă. Pătrat de 8 mm. Interax 72 mm. Intrare 42,5 mm. Grosime placă frontală 2,5 mm.



35-37PZI

Broască îngropată cu CUTIA ÎNCHISĂ, acționată cu cilindru profil european camă UNI/DIN.

Zăvorul are 2 curse de 10 mm.

Limbă reversibilă. Pătrat mâner 8 mm. Interax 90 mm.

Intrare 40 mm. Grosime placă frontală 2,5 mm.

Auriu: 35-56YORO
Negru: 35-56YNEG



MANER CU SILD JIU BUTUC Y72

ALB: 701-63ALB

MARO: 701-63MARO

Broască îngropată cu CUTIA ÎNCHISĂ, acționată cu cilindru profil European cu camă DIN. Limbă reversibilă.

Pătrat 8 mm.

Interax 55 mm.

Intrare 55 mm.

Grosime placă frontală

Disponibil ca finisaj zincat alb



35-103Y55

Broască îngropată cu CUTIA ÎNCHISĂ, acționată cu cheie.

Limbă reversibilă din poliamidă, pentru închidere silențioasă.

Pătrat de 8 mm.

Interax 90 mm.

Intrare 50 mm.

Grosime placă frontală 3 mm.



35-199

Broască îngropată pentru uși din profile de PVC. CUTIA ÎNCHISĂ CU PROTECȚIE PLASTIC, acționată cu cilindru profil european cu camă DIN. Zăvorul are 1 cursă de 16 mm.

Limbă reversibilă. Pătrat de 8 mm.

Interax 92 mm.

Intrare E 25/30/35/40 mm



35-123ZA

Broască îngropată cu CUTIA ÎNCHISĂ, acționată cu cilindru profil european cu camă UNI. Zăvorul are 2 curse de 10 mm. Limbă reversibilă. Pătrat de 8 mm. Interax 90 mm. Intrare 40 mm. Grosime placă frontală 2,5 mm.



35-29YNEG

Broască îngropată cu CUTIA ÎNCHISĂ, acționată cu cilindru profil European camă DIN. Zăvorul are 2 curse de 10,5 mm. Limbă reversibilă. Pătrat de 8 mm. Interax 90 mm. Intrare 50 mm. Grosime placă frontală 2,5 mm.



35-182Y90ZI

Broască îngropată cu CUTIA DESCHISĂ, acționată cu buton de baie. Zăvorul are 2 curse de 10 mm. Limbă reversibilă. Pătrat de 8 mm. Gaură pătrat buton 6 mm. Interax 54 mm. Intrare 42,5 mm. Grosime placă frontală 2,5 mm.



35-58ZA42.5

Broască îngropată pentru uși din profile de PVC. CUTIA ÎNCHISĂ CU PROTECȚIE PLASTIC, acționată cu cilindru profil european cu camă DIN. Zăvorul are 1 cursă de 16 mm. Limbă reversibilă. Pătrat de 8 mm. Interax 85 mm. Intrare E 25/30/35 mm.



35-118

Broască îngropată pentru uși din profile de PVC. CUTIA ÎNCHISĂ CU PROTECȚIE PLASTIC, acționată cu cilindru profil European cu camă DIN. Zăvorul are 1 cursă de 16 mm. Limbă reversibilă. Pătrat de 8 mm. Interax 90 mm. Intrare 25 mm.



35-119

Balama semi-îngropată pentru uși 116/67 mm ZINCAT GALBEN/ALB

Stanga: 210 - 09
Dreapta: 210 - 10



Balama semi-îngropată pentru uși 146,5/67 mm ZINCAT GALBEN

Stanga: 210 - 07
Dreapta: 210 - 8



Balama îngropată cu ornament, pentru uși 130,5/90 mm ZINCAT GALBEN

Stanga: 211 - 09
Dreapta: 211 - 10



Balama aplicată pentru uși 108,5/74 mm ZINCAT GALBEN

Stanga: 210 - 17
Dreapta: 210 - 18



Balama îngropată pentru uși 100/88 mm ZINCAT GALBEN

290 - 85



PRIZA SUCO CU CAPAC
PANASONIC ALB KARRE PLUS

P-KPS.CAP



PRIZA SUCO DUBLA PANASONIC
ALB KARRE PLUS

P-KPS2



INTRERUPATOR CAP SCARA
PANASONIC ALB KARRE PLUS



PRIZA TELEFON CAT3
PANASONIC ALB KARRE PLUS



PRIZA TV FINALA PANASONIC
ALB KARRE PLUS
P-KPTV.F



INTRERUPATOR MODULAR ALB
1M PANASONIC
P-T01



INTRERUPATOR MODULAR
CRUCE ALB 1M PANASONIC
P-T01.CR



INTRERUPATOR 1M MECANISM
PANASONIC
P-T01.MEC



CAPAC PT INTRERUPATOR 1M
ALB METALIC PANASONIC
P-T01.MW.C1M



TASTA FALSA MODULAR ALB 1M
PANASONIC
P-TO.C



DOZA 2 MODULE ST
PANASONIC

P-TO.D.ST.2M



DOZA 3 MODULE ST
PANASONIC

P-TO.D.ST.3M



DOZA 4 MODULE ST
PANASONIC

P-TO.D.ST.4M



DOZA 7 MODULE ST
PANASONIC

P-TO.D.ST.7M



RAMA 2 MODULE
PANASONIC
P-TO.R.2M



RAMA 3 MODULE
PANASONIC

P-TO.R.3M

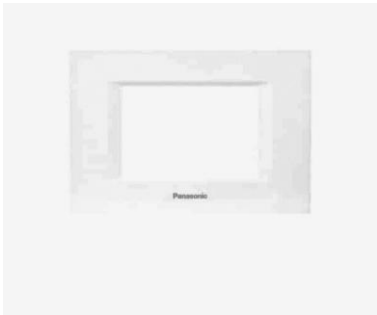

RAMA 4 MODULE
PANASONIC

P-TO.R.4M

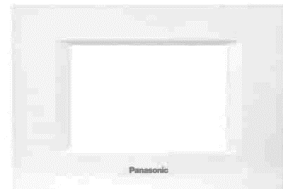

RAMA 7 MODULE
PANASONIC

P-TO.R.7M



RAMA 1/3 MODULE
PANASONIC

P-TO.R1/3M

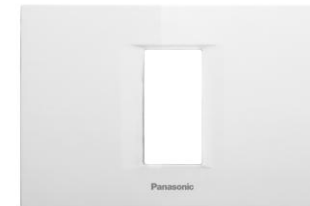

SUPORT 2 MODULE
PANASONIC

P-TO.SM2



SUPPORT 3 MODULE

P-TO.SM3



SUPPORT 4 MODULE

P-TO.SM4



SUPPORT 7 MODULE

P-TO.SM7



PRIZA TV MODULARA ALB
1M

P-TO.TV.F



PRIZA CALCULATOR
CAT6MODULAR 1M

P-TOCAL1.6



INTRERUPATOR MODULAR
CAP SCARA REVENIRE ALB
1M
P-TOIR



PRIZA SIMPLA MODULARA
ALBA 1M
P-TOP



PRIZA SCHUKO PROT COPIL
MODUL 2M ALB
P-TOS



INTRERUPATOR MODULAR
CAP SCARA ALB 1M

P-TOSC



INTRERUPATOR SCARA
MECANISM 1M

P-TOSC.MEC



CABLU FY ELECTRIC ALBASTRU



- 1.5 (10 ML)
- 1.5 (25 ML)
- 1.5 (50 ML)
- 1.5 (100 ML)
- 2.5 (10 ML)
- 2.5 (25 ML)
- 2.5 (50 ML)
- 2.5 (100 ML)

CABLU FY ELECTRIC ROSU



- 1.5 (10 ML)
- 1.5 (25 ML)
- 1.5 (50 ML)
- 1.5 (100 ML)
- 2.5 (10 ML)
- 2.5 (25 ML)
- 2.5 (50 ML)
- 2.5 (100 ML)

CABLU FY ELECTRIC NEGRU



- 1.5 (10 ML)
- 1.5 (25 ML)
- 1.5 (50 ML)
- 1.5 (100 ML)
- 2.5 (10 ML)
- 2.5 (25 ML)
- 2.5 (50 ML)
- 2.5 (100 ML)

CABLU FY ELECTRIC GALBEN-VERDE



- 1.5 (10 ML)
- 1.5 (25 ML)
- 1.5 (50 ML)
- 1.5 (100 ML)
- 2.5 (10 ML)
- 2.5 (25 ML)
- 2.5 (50 ML)
- 2.5 (100 ML)

CABLU FY ELECTRIC MARO



- 1.5 (10 ML)
- 1.5 (25 ML)
- 1.5 (50 ML)
- 1.5 (100 ML)
- 2.5 (10 ML)
- 2.5 (25 ML)
- 2.5 (50 ML)
- 2.5 (100 ML)

CABLU MYYM



- 3X1.5 (10 ML)
- 3X1.5 (25 ML)
- 3X1.5 (50 ML)
- 3X1.5 (100 ML)
- 3X2.5 (10ML)
- 3X2.5 (25ML)
- 3X2.5 (50ML)
- 3X2.5 (100ML)

CABLU MYYM



- 2*0.75 (100 M)
- 2X1 (100M)
- 2X1.5 (100 ML)
- 2X2.5 (100 ML)



CABLU MYYM

- 5X1 (100 M)
- 5X1.5 (100 M)
- 5X4
- 5X6
- 5X10

CABLU MYF



- 1.5 (100 M)
- 2.5 (100 M)
- 6 (100ML)

CABLU CYYF 4X1.5



CABLU MYYUP



- 2X0.5 (100 ML)
- 2X 0.75 (100 ML)
- 2X1 (100ML)

CABLU CYAbY-F



- 3X10
- 5X10

CABLU UTP CAT 5E (305ML)

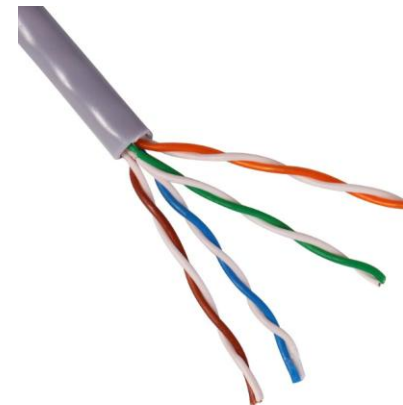

**COPEX Ø16mm
 Ø20mm**



SINA+ACC+FINAL

1.5/2/2.5/3/3.5/4 m



**ACCESORII SINA
PERDEA**

1.5/2/2.5/3/3.5/4 m



RAMA AERISIRE

Ø 50/70/100/
110/120/140



**RAMA AERISIRE
cu plasa**



150*150
150*200
200*200
200*300
300*300

USITA VIZITARE PLASTIC

150*150
150*200
200*200
200*300
200*400
200*250
300*300
300*400
400*400



**USITA DE VIZITARE DIN
METAL**

200*200
300*200
200*250
250*250
250*300
300*300
400*400
400*500
500*500
600*600



DISTANTIER

1 MM
1.5
2
2
2.5
3
4
5



TABLOU ELECTIC

4/6/8/12/24 SIGURANTE



**RACORD FLEXIBIL
PENTRU RACORDARE
VAS WC**

300-500/ 1000



**REDUCTIE UNIVERSALA
D80-100-120-125-150**



Profil Soclu

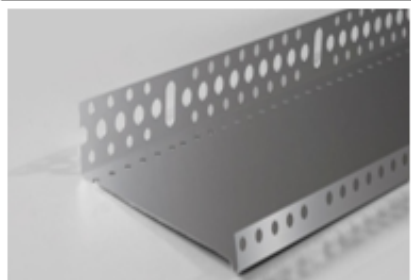

TIP	Greutate	Pack	Lungime
103mm	0.36	20 pcs	2m
103mm	0.45	20pcs	2.5m

GROSIME	0.6
---------	-----

Coltar aluminiu simplu perforat

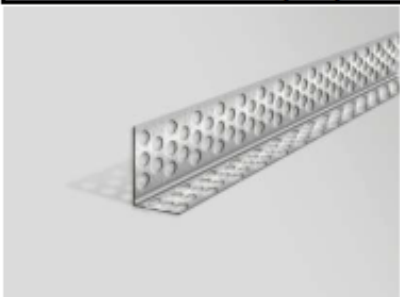

30x30	Greutate	Pack	Lungime
0.35mm	0.13	50 pcs	2.5m
	0.16	50 pcs	3.0m

23x23mm	Greutate	Pack	Lungime
0.3mm	0.07	50 pcs	2.5m
	0.09	50 pcs	3.0m

Profil arcuibil din PVC

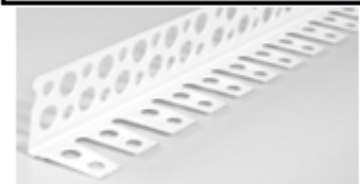

Greutate	Pack	Lungime
0.125	50pcs	2.5m
0.15	50pcs	3.0m

Profil etansare ferestre alb



Tip	Greutate	Pack	Lungime
6mm	0.15	50pcs	2.5m
6mm	0.17	50pcs	3.0m

Culori: maro, gri antracit, stejar +5%

Profil de colt pentru tencuiala din otel zincat



Tape 0.6mm

Tip	Pack	Lungime
34*34	25pcs	2.5m
34*34	25pcs	3m

Sina ghidaj din otel zincat



Tip	Greutate	Pack	Lungime
W6	0.22	25pcs	3m

Profil PVC cu plasa fibra de sticla

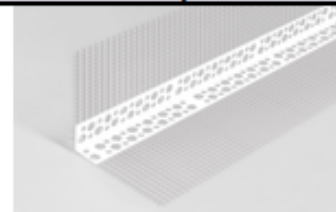

Tip	Greutate	Pack	Lungime
7*7	0.13	25pcs	2.5 m
7*7	0.16	25pcs	3.0 m
10*10	0.15	25pcs	2.5m
10*10	0.18	25pcs	3m

Profil din PVC cu picurator

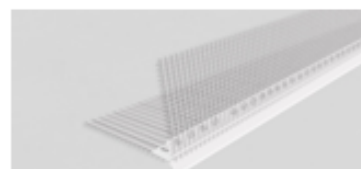

Greutate	Pack	Lungime
0.2	30pcs	2.5m

PRODUCTIE ROMANIA

4.3

Profil etansare ferestre cu plasa fibra de sticla ALB

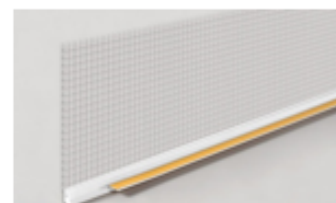

Tip	Greutate	Pack	Lungime
6 mm	0.19	25pcs	2.5m

Culori: maro, gri antracit, stejar +5%